



better together

50Hz

X - B - Y series

- DGX
- DRX
- DGB
- DRB
- DRY

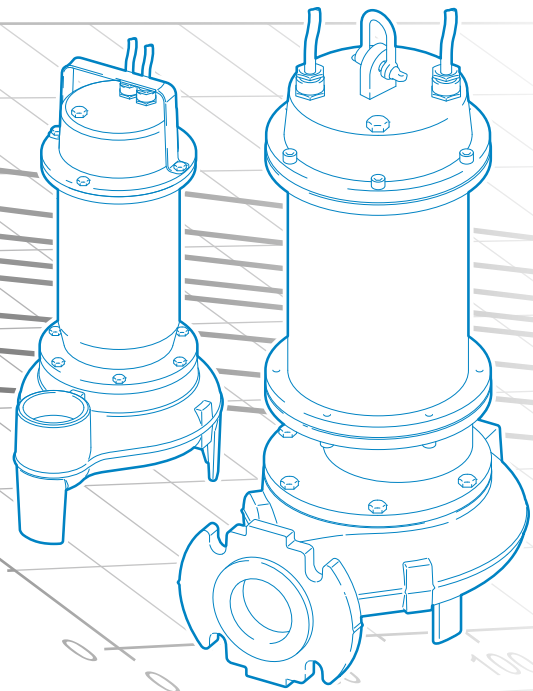

D A T A B O O K L E T

zenit.com

EN



better together

X - B - Y SERIES

DGX

DRX

DGB

DRB

DRY



D A T A B O O K L E T

X Series

General characteristics



- AISI 316 stainless steel lifting and carrying handle.
- CF-8M steel construction which makes the pump suitable for use in saline environments.
- Oil-bath motor with thermal protections.
- Shielded ball bearings with lifetime autolubrication
- Two mechanical seals in silicon carbide (2SiC).
- Wide free passage allowing the expulsion of solids and preventing fouling of the impeller (DGO)
- Intake strainer in stainless steel (DRO)

Hydraulic families



DG (Draga)

page 7

- Vortex impeller in CF-8M steel.
- Ideal for lifting strongly corrosive or aggressive strained liquids, especially in the chemical industry. Intended for specific industrial applications.



DR (Dreno)

page 15

- Multichannel open impeller in CF-8M steel.
- Designed for the treatment of strongly corrosive or chemically aggressive liquids, especially in the chemical industry, this unit is for a specific industrial application.

Operating ranges

DGX

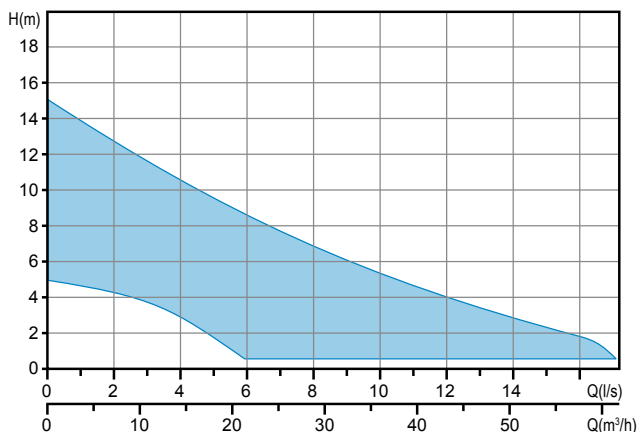

DRX

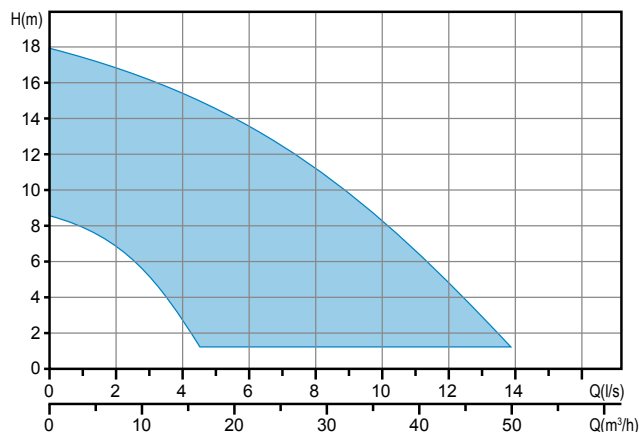

Versions available

• Electrical variants

Single-phase models

T	Thermal protection
TCST	Thermal protection, capacitor, electrical cabinet, overload protection
TCSGT	Thermal protection, capacitor, float switch, electrical cabinet, overload protection

Three-phase models

NAE	No electric accessories installed
------------	-----------------------------------

• Cooling system

N	No cooling and/or seal flushing system
----------	--

• Set of mechanical seals

2SiC	Two mechanical seals in silicon carbide (2SiC).
-------------	---

Key to product code

DRX 50/2/G32V A0BM5

① ② ③ (A) (B) (C) ④ ⑤ ⑥ ⑦ ⑧ ⑨

- | | |
|--------------------------------|----------------------------------|
| ① Family | ⑤ Hydraulic model |
| ② Series | ⑥ Version number |
| ③ Power (HP×100) / motor poles | ⑦ Motor size |
| ④ Delivery rate | ⑧ Motor phases |
| (A) TYPE (GAS thread/Flanged) | M = Single-phase |
| (B) DIAMETER (mm) | T = Three-phase |
| (C) POSITION | ⑨ Power supply voltage frequency |
| V = vertical | 5 = 50Hz |
| H = horizontal | 6 = 60Hz |

Installations

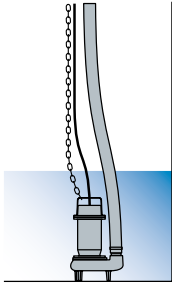

Free installation

The electric pump, standing on its feet or base, is connected to the delivery flexible pipe using a joint fixed to the discharge. This installation allows to move easily the electrical pump

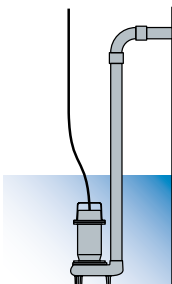

Fixed installation

The electric pump, standing on its feet or base, is connected to the delivery pipe, which is screwed to the discharge if threaded, or fixed to a bend if the port is flanged. The pump-hose connection may be threaded or flanged, depending on the pump fitting.

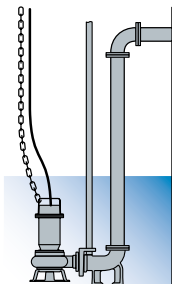

Installation with base coupling foot

For submerged installation, available for electric pumps with flanged or threaded horizontal discharge. The coupling device is fixed to the bottom of the tank and the pump is lowered in with the aid of two guide pipes fitted earlier, until the connection to the foot is completed. The delivery pipe is fixed to the coupling device discharge. This device makes routine checks, any maintenance work or replacement of the pump extremely easy, with no need to empty the tank.

Pumps with vortex impeller

Operating ranges

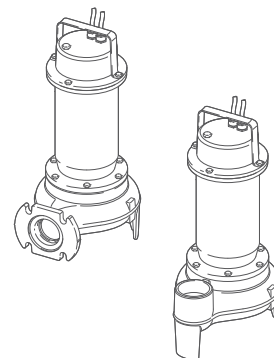
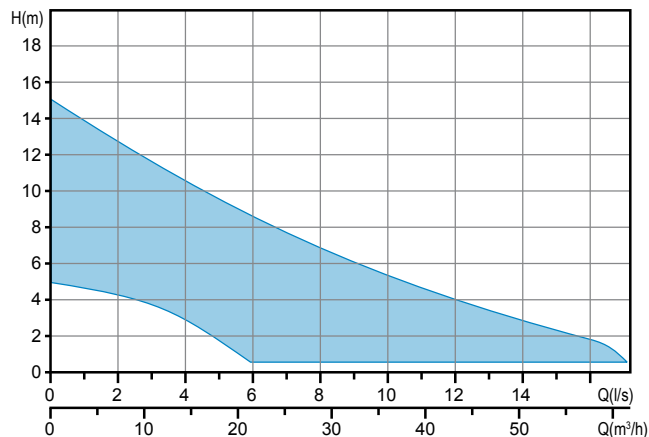

Range characteristics

Motor power	0.37 ÷ 1.5 kW
Poles	2 / 4
Insulation class	F
Degree of protection	IP68
Discharge	GAS 2" vertical DN65 - DN80 horizontal
Free passage	max 60 mm
Max flow rate	18.4 l/s (1104 l/min)
Max head	14.9 m

Motor

Oil bath motor with thermal protections.

Cable

H07RN-F 4G1 - 5 m cable length. Optional 10 m cable length.

Mechanical seals

Two silicon carbide mechanical seals (2SiC)

Applications

Ideal for lifting strongly corrosive or aggressive strained liquids, especially in the chemical industry. Intended for specific industrial applications.

Installations

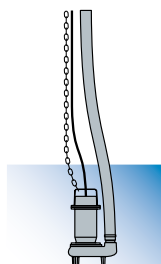

FREE

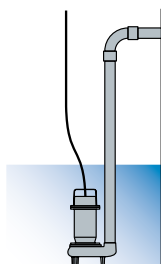

FIXED

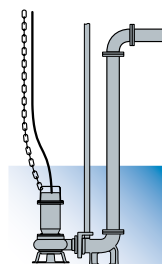

with BASE COUPLING FOOT

Versions

Electrical variants	T, TCST, TCSGT (single-phase models) NAE (three-phase models)
Cooling system	N
Mechanical seals	2SiC

Operating specifications

Max operating temperature	40 °C
PH of treated fluid	5 ÷ 10
Viscosity of treated fluid	1 mm²/s
Maximum immersion depth	20 m
Density of treated fluid	1 Kg/dm³
Acoustic pressure max	<70dB
Max starts per hour	30

Construction materials

Case	Cast stainless steel - CF-8M (AISI 316)
Hydraulic parts	Cast stainless steel - CF-8M (AISI 316)
Impeller	Stainless steel
Nuts and bolts	Stainless steel - Class A2-70
Standard gasket	Rubber - VITON
Shaft	Stainless steel - AISI 316
Paint type	-

DGX 2/G50V

Performances

	l/s	0	1	2	3	4	5	6	7	8	9	10
	l/min	0	60	120	180	240	300	360	420	480	540	600
	m³/h	0	3.6	7.2	10.8	14.4	18.0	21.6	25.2	28.8	32.4	36.0
① DGX 50/2/G50V A0CM(T)5		7.6	6.5	5.4	4.3	3.2	2.1					
② DGX 75/2/G50V A0CM(T)5		8.4	7.4	6.3	5.3	4.3	3.3	2.4				
③ DGX 100/2/G50V A0CM(T)5		12.1	11.1	10.0	8.9	7.8	6.7	5.4	4.2	2.9		
④ DGX 150/2/G50V A0CM(T)5		13.9	12.8	11.7	10.6	9.4	8.2	7.0	5.8	4.6	3.3	
⑤ DGX 200/2/G50V A0CM(T)5		14.9	13.7	12.6	11.5	10.3	9.1	7.9	6.7	5.5	4.2	2.9

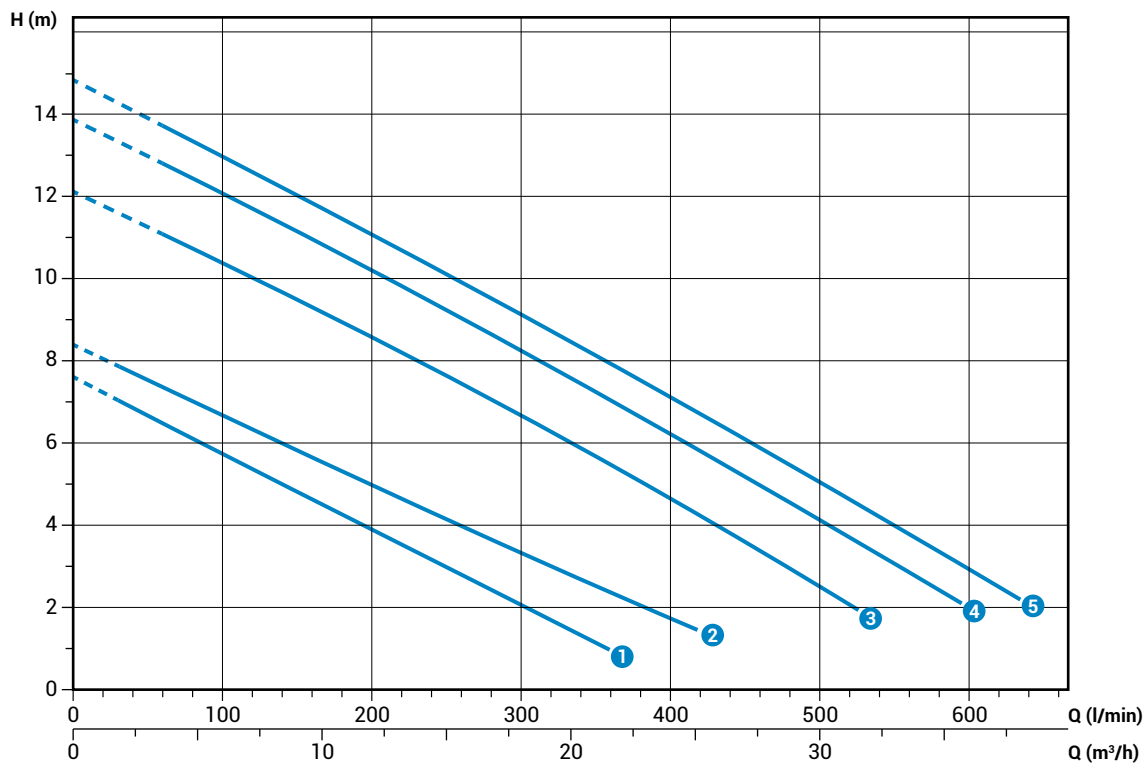

Characteristic curves according to UNI EN ISO 9906

Technical data

	V	Phases	P1 (kW)	P2 (kW)	A	Rpm	Start	Cable	Ø	Free passage
① DGX 50/2/G50V A0CM5	230	1	-	0.37	2.9	2900	Dir	4G1	G 2"	38 mm
② DGX 75/2/G50V A0CM5	230	1	-	0.55	3.9	2900	Dir	4G1	G 2"	38 mm
③ DGX 100/2/G50V A0CM5	230	1	-	0.88	6.5	2900	Dir	4G1	G 2"	38 mm
④ DGX 150/2/G50V A0CM5	230	1	-	1.1	8.2	2900	Dir	4G1	G 2"	38 mm
⑤ DGX 200/2/G50V A0CM5	230	1	-	1.5	9.3	2900	Dir	4G1	G 2"	38 mm

	V	Phases	P1 (kW)	P2 (kW)	A	Rpm	Start	Cable	Ø	Free passage
① DGX 50/2/G50V A0CT5	400	3	-	0.37	1.1	2900	Dir	4G1	G 2"	38 mm
② DGX 75/2/G50V A0CT5	400	3	-	0.55	1.42	2900	Dir	4G1	G 2"	38 mm
③ DGX 100/2/G50V A0CT5	400	3	-	0.88	2.3	2900	Dir	4G1	G 2"	38 mm
④ DGX 150/2/G50V A0CT5	400	3	-	1.1	2.7	2900	Dir	4G1	G 2"	38 mm
⑤ DGX 200/2/G50V A0CT5	400	3	-	1.5	3.5	2900	Dir	4G1	G 2"	38 mm

Performances

	l/s	0	2	4	6	8	10	12	14
	l/min	0	120	240	360	480	600	720	840
	m³/h	0	7.2	14.4	21.6	28.8	36.0	43.2	50.4
1	DGX 150/2/65 A0CM(T)5	9.1	8.5	7.7	6.7	5.5	4.1	2.5	
2	DGX 200/2/65 A0CM/(T)5	9.6	9.1	8.4	7.5	6.4	5.1	3.7	2.0

Characteristic curves according to UNI/EN ISO 9906

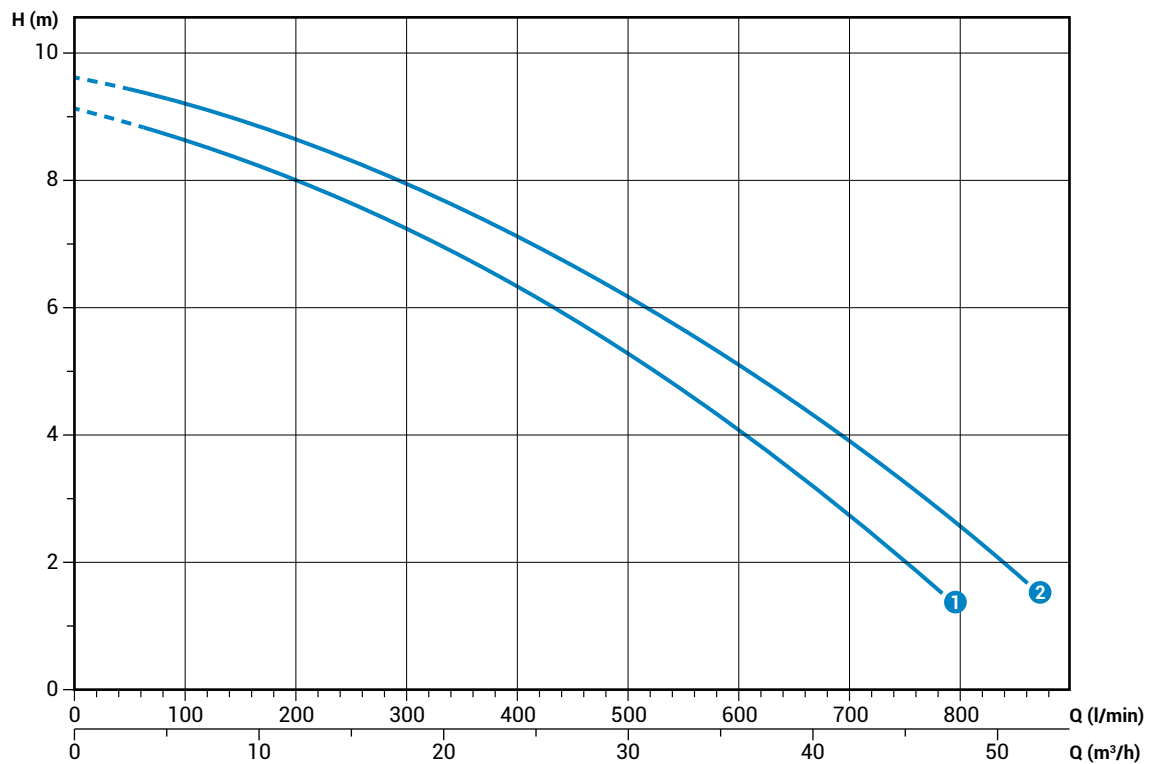

Technical data

	V	Phases	P1 (kW)	P2 (kW)	A	Rpm	Start	Cable	Ø	Free passage	
1	DGX 150/2/65 A0CM5	230	1	-	1.1	8.2	2900	Dir	4G1	DN65	50 mm
2	DGX 200/2/65 A0CM5	230	1	-	1.5	9.3	2900	Dir	4G1	DN65	50 mm

	V	Phases	P1 (kW)	P2 (kW)	A	Rpm	Start	Cable	Ø	Free passage	
1	DGX 150/2/65 A0CT5	400	3	-	1.1	2.7	2900	Dir	4G1	DN65	50 mm
2	DGX 200/2/65 A0CT5	400	3	-	1.5	3.5	2900	Dir	4G1	DN65	50 mm

DGX 2/80

Performances

	0	2	4	6	8	10	12	14	16
l/s	0	2	4	6	8	10	12	14	16
l/min	0	120	240	360	480	600	720	840	960
m ³ /h	0	7.2	14.4	21.6	28.8	36.0	43.2	50.4	57.6
① DGX 200/2/80A A0CM(T)5	8.1	7.5	6.8	5.9	5.1	4.3	3.5	2.7	1.9

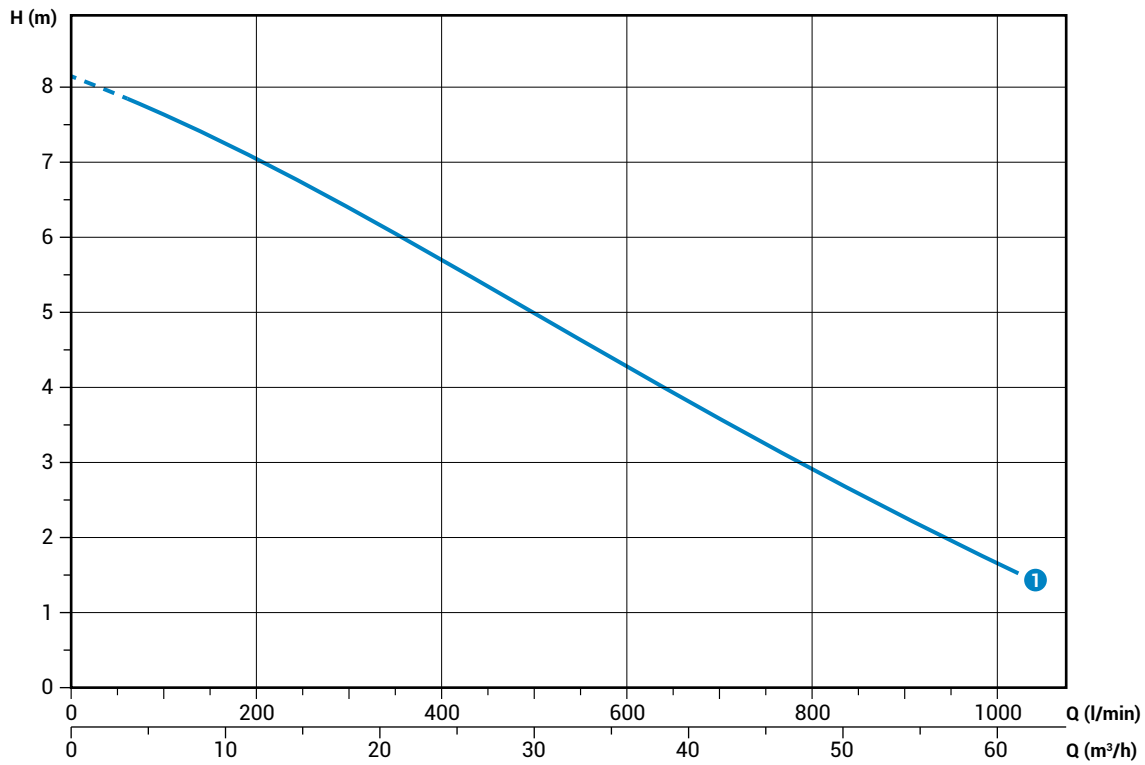

Characteristic curves according to UNI/EN ISO 9906

Technical data

	V	Phases	P1 (kW)	P2 (kW)	A	Rpm	Start	Cable	Ø	Free passage
① DGO 50/2/G50H A1CM5	230	1	-	1.5	9.3	2900	Dir	4G1	DN80	60 mm

	V	Phases	P1 (kW)	P2 (kW)	A	Rpm	Start	Cable	Ø	Free passage
① DGO 50/2/G50H A1CT5	400	3	-	1.5	3.5	2900	Dir	4G1	DN80	60 mm

DGX 4/G50V

Performances

	l/s	0	1	2	3	4	5	6	7	8
	l/min	0	60	120	180	240	300	360	420	480
	m ³ /h	0	3.6	7.2	10.8	14.4	18.0	21.6	25.2	28.8
① DGX 100/4/G50V A0CM(T)5		5.0	4.7	4.4	4.1	3.8	3.5	3.1	2.5	1.6

Characteristic curves according to UNI/EN ISO 9906

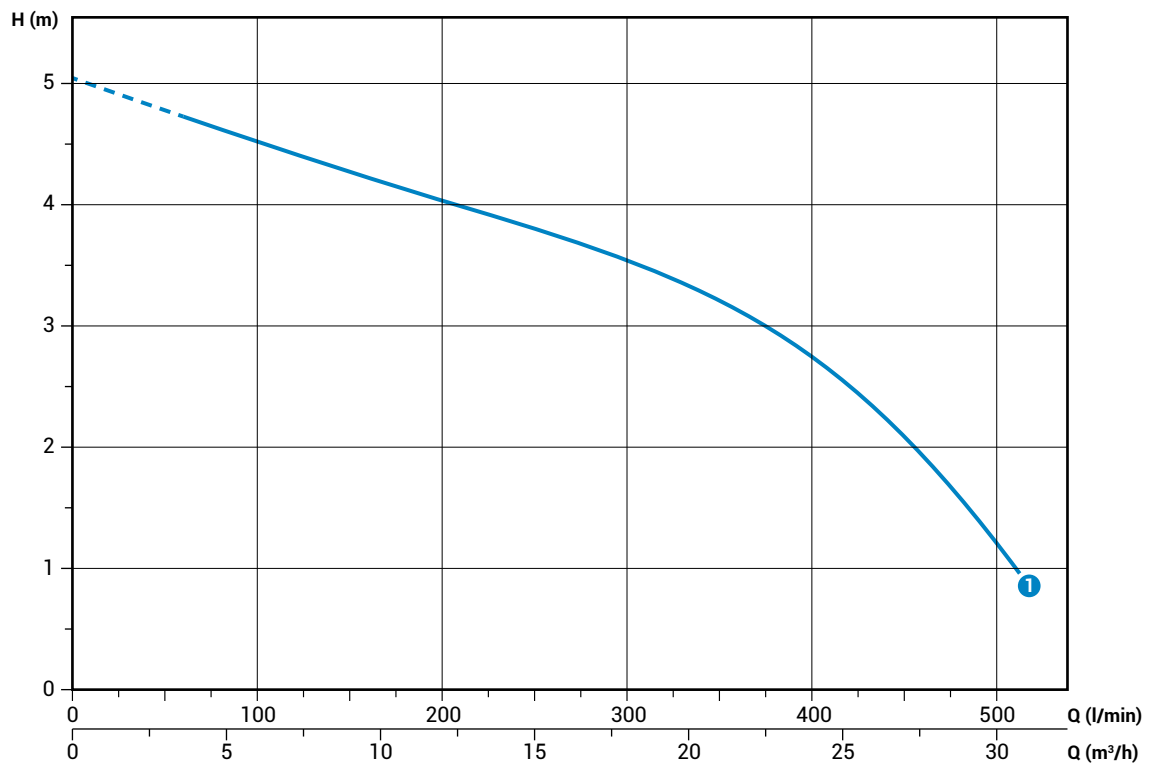

Technical data

	V	Phases	P1 (kW)	P2 (kW)	A	Rpm	Start	Cable	Ø	Free passage
① DGX 100/4/G50V A0CM5	230	1	-	0.63	4.5	1450	Dir	4G1	G 2"	20 mm

	V	Phases	P1 (kW)	P2 (kW)	A	Rpm	Start	Cable	Ø	Free passage
① DGX 100/4/G50V A0CT5	400	3	-	0.63	1.82	1450	Dir	4G1	G 2"	20 mm

DGX 4/65

Performances

	l/s	0	2	4	6	8	10	12
	l/min	0	120	240	360	480	600	720
	m ³ /h	0	7.2	14.4	21.6	28.8	36.0	43.2
① DGX 150/4/65 A0CM(T)5		5.6	5.3	4.8	4.3	3.6	2.8	1.8

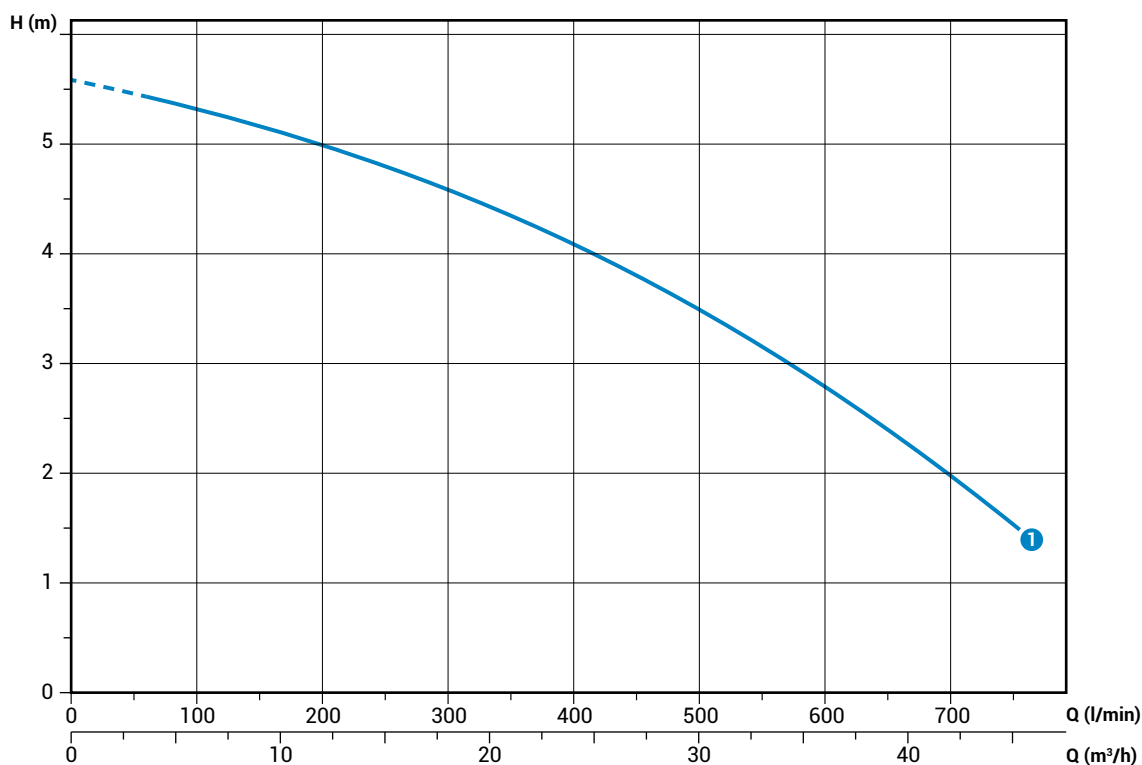

Characteristic curves according to UNI/EN ISO 9906

Technical data

	V	Phases	P1 (kW)	P2 (kW)	A	Rpm	Start	Cable	Ø	Free passage
① DGX 150/4/65 A0CM5	230	1	-	0.9	6.3	1450	Dir	4G1	DN65	45 mm

	V	Phases	P1 (kW)	P2 (kW)	A	Rpm	Start	Cable	Ø	Free passage
① DGX 150/4/65 A0CT5	400	3	-	0.9	2.2	1450	Dir	4G1	DN65	45 mm

Performances

	0	2	4	6	8	10	12	14	16	18
l/s	0	2	4	6	8	10	12	14	16	18
l/min	0	120	240	360	480	600	720	840	960	1080
m ³ /h	0	7.2	14.4	21.6	28.8	36.0	43.2	50.4	57.6	64.8
① DGX 150/4/80 A0CM(T)5	5.1	4.8	4.5	4.0	3.5	3.1	2.6	2.1	1.6	1.1

Characteristic curves according to UNI/EN ISO 9906

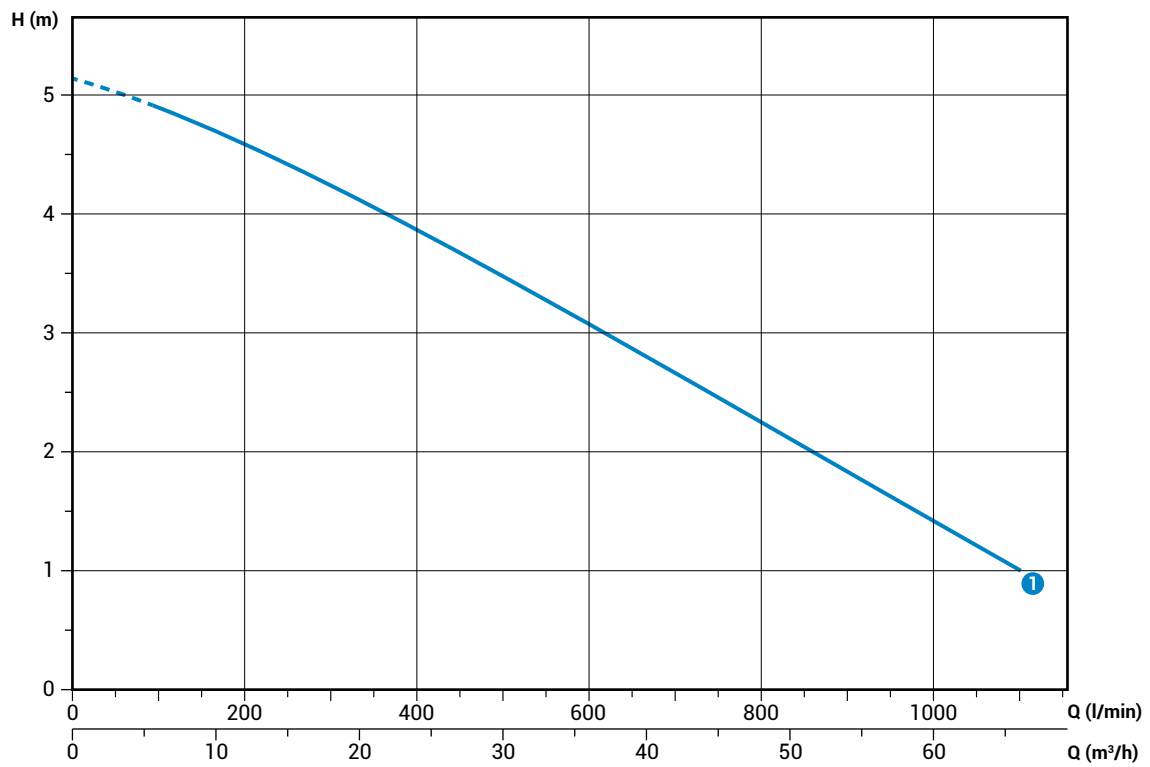

Technical data

	V	Phases	P1 (kW)	P2 (kW)	A	Rpm	Start	Cable	Ø	Free passage
① DGX 150/4/80 A0CM5	230	1	-	0.9	6.3	1450	Dir	4G1	DN80	60 mm
	V	Phases	P1 (kW)	P2 (kW)	A	Rpm	Start	Cable	Ø	Free passage
① DGX 150/4/80 A0CT5	400	3	-	0.9	2.23	1450	Dir	4G1	DN80	60 mm

DGX

Overall dimensions and weights

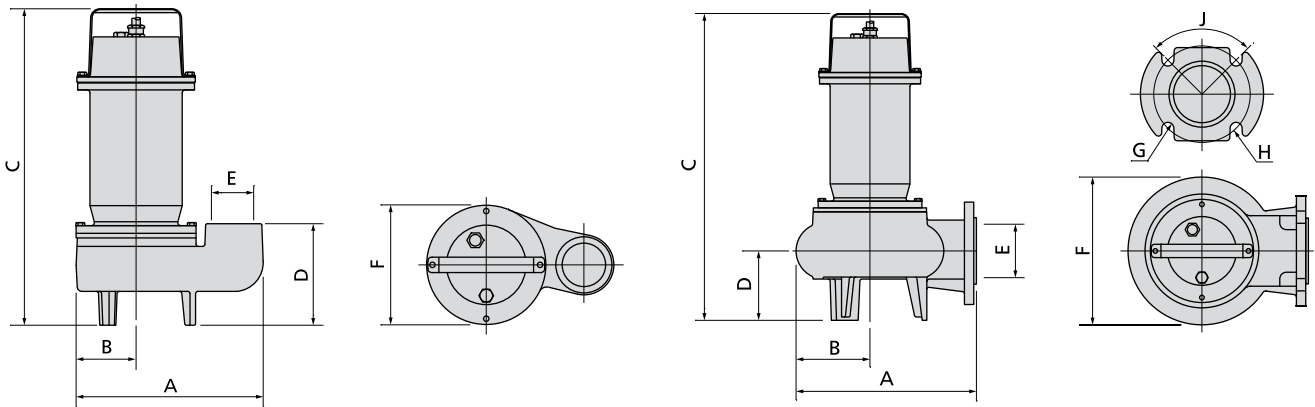

Models with vertical discharge

	A	B	C	D	E	F	kg
DGX 50/2/G50V A0CM(T)5	225	75	360	120	G 2"	155	18
DGX 75/2/G50V A0CM(T)5	225	75	360	120	G 2"	155	18
DGX 100/2/G50V A0CM(T)5	245	80	410	130	G 2"	155	22
DGX 150/2/G50V A0CM(T)5	245	80	410	130	G 2"	155	23
DGX 200/2/G50V A0CM(T)5	245	80	410	130	G 2"	155	22
DGX 100/4/G50V A0CM(T)5	245	80	410	130	G 2"	155	22

Dimensions in mm

Models with horizontal discharge

	A	B	C	D	E	F	G	H	J	kg
DGX 150/2/65 A0CM(T)5	270	110	460	105	65	220	18	145	90°	28
DGX 200/2/65 A0CM(T)5	270	110	460	105	65	220	18	145	90°	29
DGX 200/2/80 A0CM(T)5	270	110	460	105	80	220	18	160	90°	33.5
DGX 150/4/65 A0CM(T)5	270	110	460	105	65	220	18	145	90°	29
DGX 150/4/80 A0CM(T)5	295	120	470	115	80	220	18	160	90°	33.5

Dimensions in mm

Packaging dimension



	X	Y	Z
DGX 50/2/G50V A0CM(T)5	225	385	245
DGX 75/2/G50V A0CM(T)5	225	385	245
DGX 100/2/G50V A0CM(T)5	285	475	235
DGX 150/2/G50V A0CM(T)5	285	475	235
DGX 200/2/G50V A0CM(T)5	285	475	235
DGX 100/4/G50V A0CM(T)5	310	580	310
DGX 150/2/65 A0CM(T)5	310	580	310
DGX 200/2/65 A0CM(T)5	310	580	310
DGX 200/2/80 A0CM(T)5	310	580	310
DGX 150/4/65 A0CM(T)5	310	580	310
DGX 150/4/80 A0CM(T)5	310	580	310

Dimensions in mm

Pumps with multi-channel open impeller

Operating ranges

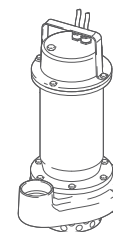
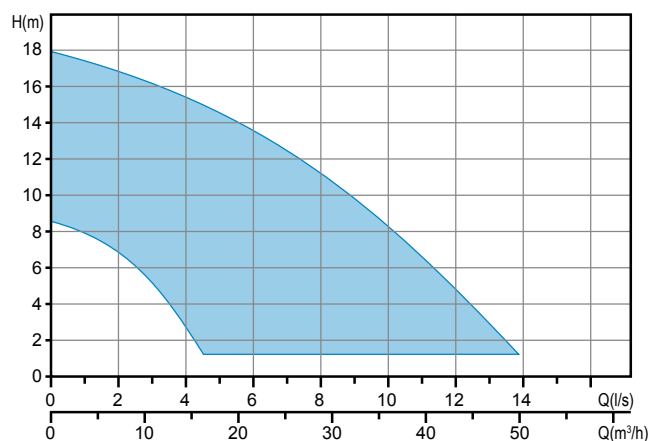

Range characteristics

Motor power	0.37 ÷ 1.5 kW
Poles	2
Insulation class	F
Degree of protection	IP68
Discharge	GAS 1¼ ÷ 2" vertical
Free passage	max 15 mm
Max flow rate	12.5 l/s (750 l/min)
Max head	17.8 m

Motor

Oil bath motor with thermal protections.

Cable

H07RN-F 4G1 - 5 m cable length. Optional 10 m cable length.

Mechanical seals

Two silicon carbide mechanical seals (2SiC)

Applications

Designed for the treatment of strongly corrosive or chemically aggressive liquids, especially in the chemical industry, this unit is for a specific industrial application.

Installations

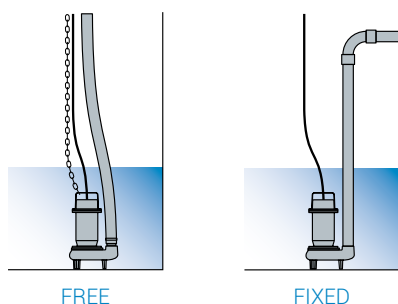

Versions

Electrical variants	T, TCST, TCSGT (single-phase models) NAE (three-phase models)
Cooling system	N
Mechanical seals	SICAL

Operating specifications

Max operating temperature	40 °C
PH of treated fluid	3 ÷ 14
Viscosity of treated fluid	1 mm²/s
Maximum immersion depth	20 m
Density of treated fluid	1 Kg/dm³
Acoustic pressure max	<70dB
Max starts per hour	30

Construction materials

Case	Cast stainless steel - CF-8M (AISI 316)
Hydraulic parts	Cast stainless steel - CF-8M (AISI 316)
Impeller	Stainless steel
Nuts and bolts	Stainless steel - Class A2-70
Standard gasket	Rubber - VITON
Shaft	Stainless steel - AISI 316
Paint type	-

DRX 2/G32V

Performances

	l/s	0	1	2	3	4	5	6
	l/min	0	60	120	180	240	300	360
	m ³ /h	0	3.6	7.2	10.8	14.4	18.0	21.6
①	DRX 50/2/G32V A0CM(T)5	8.5	7.8	6.7	5.1	2.6		
②	DRX 75/2/G32V A0CM(T)5	11.8	11.5	10.5	8.9	6.7	4.1	1.0

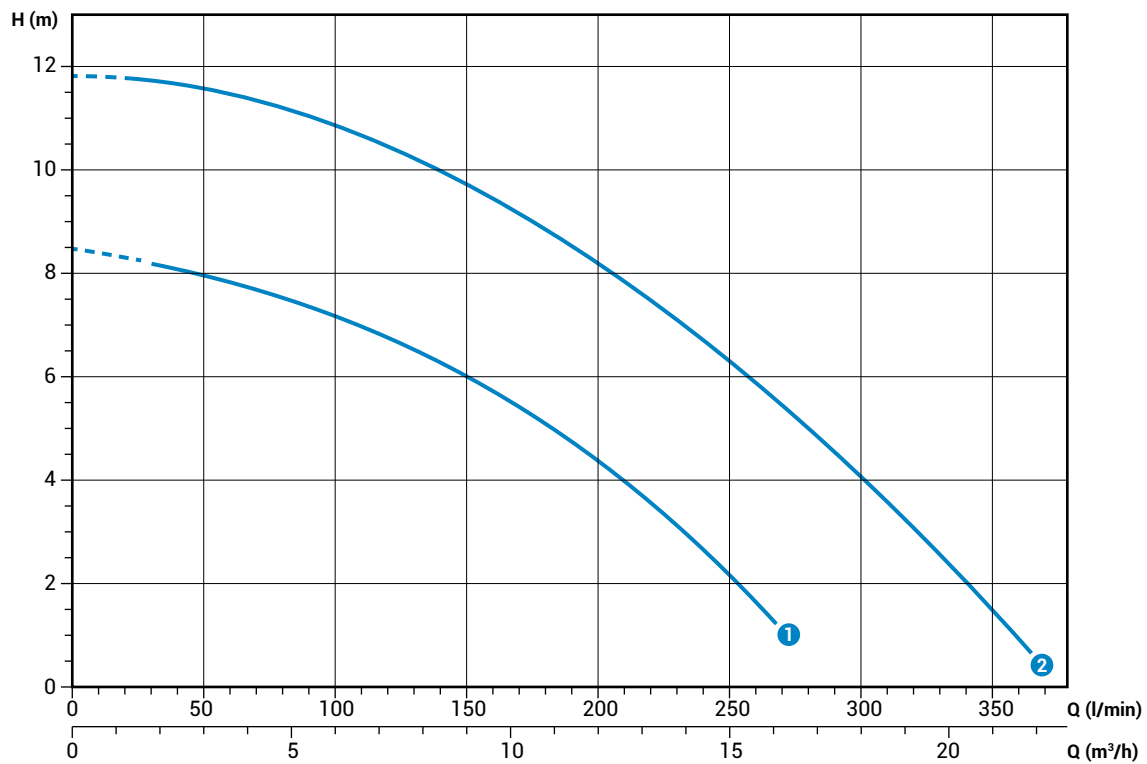

Characteristic curves according to UNI/EN ISO 9906

Technical data

	V	Phases	P1 (kW)	P2 (kW)	A	Rpm	Start	Cable	Ø	Free passage	
①	DRX 50/2/G32V A0CM5	230	1	-	0.37	2.9	2900	Dir	4G1	G 1¼"	15 mm
②	DRX 75/2/G32V A0CM5	230	1	-	0.55	3.9	2900	Dir	4G1	G 1¼"	15 mm

	V	Phases	P1 (kW)	P2 (kW)	A	Rpm	Start	Cable	Ø	Free passage	
①	DRX 50/2/G32V A0CT5	400	3	-	0.37	1.1	2900	Dir	4G1	G 1¼"	15 mm
②	DRX 75/2/G32V A0CT5	400	3	-	0.55	1.4	2900	Dir	4G1	G 1¼"	15 mm

DRX 2/G50V

Performances

	I/s	0	2	4	6	8	10	12
	l/min	0	120	240	360	480	600	720
	m ³ /h	0	7.2	14.4	21.6	28.8	36	43.2
① DRX 100/2/G50V A0CM(T)5		12.0	11.1	9.7	7.6	4.8		
② DRX 150/2/G50V A0CM(T)5		15.8	14.8	13.4	11.5	9.0	5.9	
③ DRX 200/2/G50V A0CM(T)5		17.8	16.7	15.2	13.4	11.1	8.3	4.8

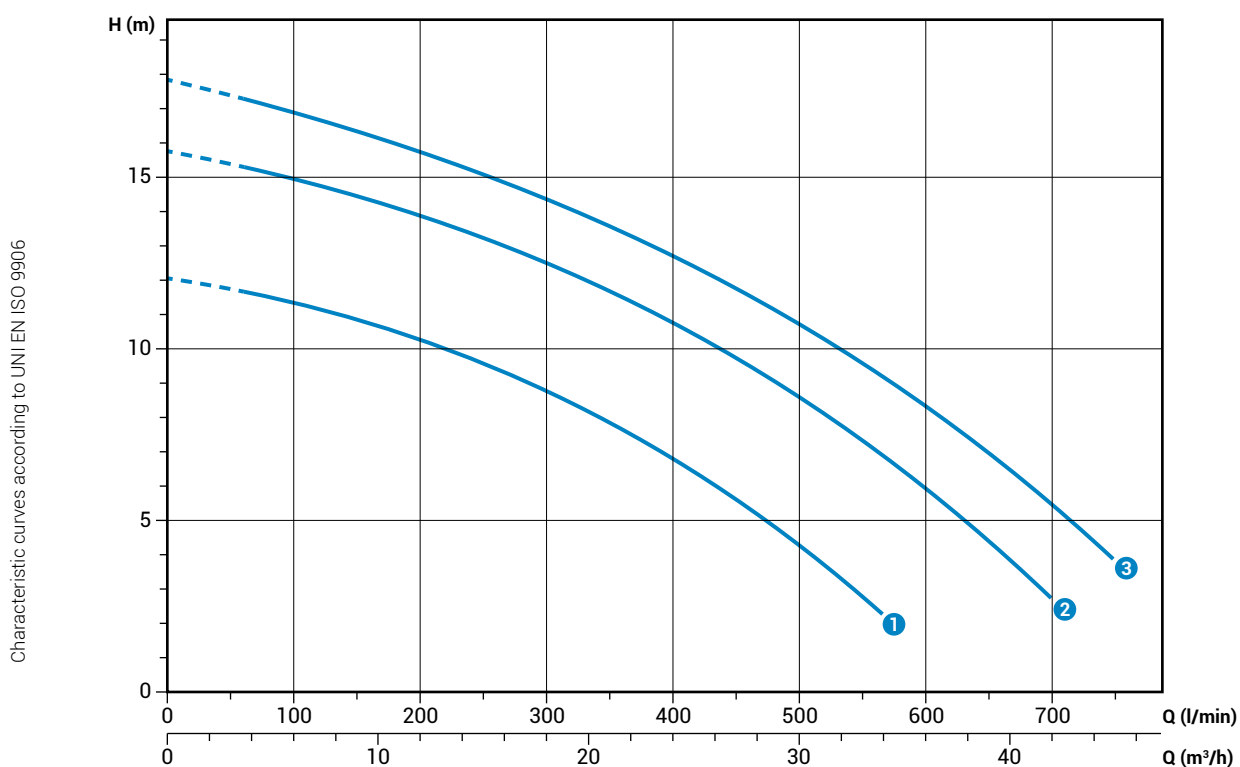

Technical data

	V	Phases	P1 (kW)	P2 (kW)	A	Rpm	Start	Cable	Ø	Free passage
① DRX 100/2/G50V A0CM5	230	1	-	0.88	6.5	2900	Dir	4G1	G 2"	15 mm
② DRX 150/2/G50V A0CM5	230	1	-	1.1	8.2	2900	Dir	4G1	G 2"	15 mm
③ DRX 200/2/G50V A0CM5	230	1	-	1.5	9.3	2900	Dir	4G1	G 2"	15 mm

	V	Phases	P1 (kW)	P2 (kW)	A	Rpm	Start	Cable	Ø	Free passage
① DRX 100/2/G50V A0CT5	400	3	-	0.88	2.3	2900	Dir	4G1	G 2"	15 mm
② DRX 150/2/G50V A0CT5	400	3	-	1.1	2.7	2900	Dir	4G1	G 2"	15 mm
③ DRX 200/2/G50V A0CT5	400	3	-	1.5	3.5	2900	Dir	4G1	G 2"	15 mm

DRX

Overall dimensions and weights

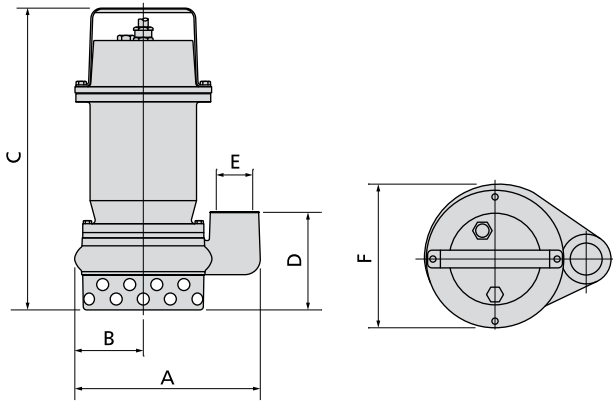

	A	B	C	D	E	F	kg
DRX 50/2/G32V A0CM(T)5	210	75	340	110	G 1 1/4"	160	17
DRX 75/2/G32V A0CM(T)5	210	75	340	110	G 1 1/4"	160	17
DRX 100/2/G50V A0CM(T)5	265	100	390	125	G 2"	190	21
DRX 150/2/G50V A0CM(T)5	265	100	390	125	G 2"	190	23
DRX 200/2/G50V A0CM(T)5	265	100	390	125	G 2"	190	23

Dimensions in mm

Packaging dimension



	X	Y	Z
DRX 50/2/G32V A0CM5	225	385	245
DRX 75/2/G32V A0CM5	225	385	245
DRX 100/2/G50V A0CM5	285	475	235
DRX 150/2/G50V A0CM5	285	475	235
DRX 200/2/G50V A0CM5	285	475	235
DRX 50/2/G32V A0CT5	225	385	245
DRX 75/2/G32V A0CT5	225	385	245
DRX 100/2/G50V A0CT5	285	475	235
DRX 150/2/G50V A0CT5	285	475	235
DRX 200/2/G50V A0CT5	285	475	235

Dimensions in mm

B Series

General characteristics



- AISI 316 stainless steel lifting and carrying handle.
- B10 bronze construction which makes the pump suitable for use with chemically aggressive liquids.
- Oil-bath motor with thermal protections.
- Shielded ball bearings with lifetime autolubrication
- Two mechanical seals in silicon carbide (2SiC).
- Wide free passage allowing the expulsion of solids and preventing fouling of the impeller (DGB)
- Intake strainer in stainless steel (DRB)

Hydraulic families



DG (Draga)

page 22

- Vortex impeller in B10 bronze.
- Suitable for lifting chemically aggressive soiled liquids, dyes and seawater. These units are therefore ideal for applications in the tanning industry, the paper industry and the shipping sector.



DR (Dreno)

page 25

- Multichannel open impeller in B10 bronze.
- Suitable for treating chemically aggressive strained liquids, dyes and seawater. Can be used for applications in the tanning industry and the shipping sector.

Operating ranges

DGB

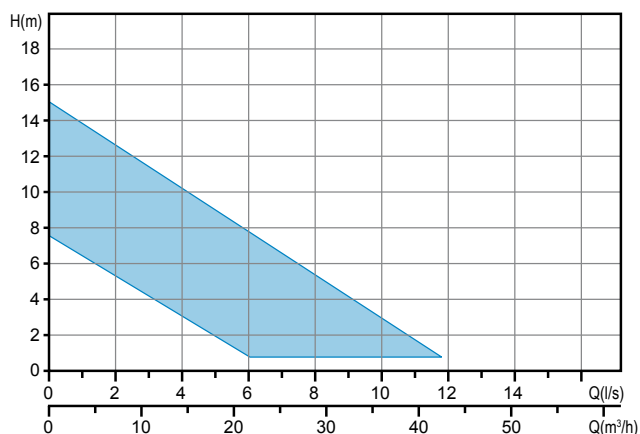

DRB

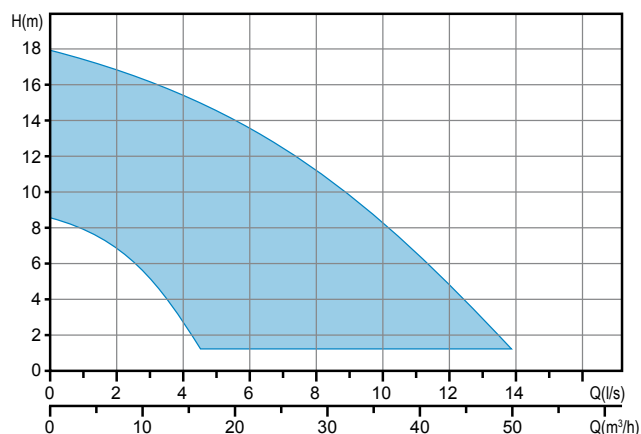

Versions available

• Electrical variants

Single-phase models

T	Thermal protection
TCST	Thermal protection, capacitor, electrical cabinet, overload protection
TCSGT	Thermal protection, capacitor, float switch, electrical cabinet, overload protection

Three-phase models

NAE	No electric accessories installed
------------	-----------------------------------

• Cooling system

N	No cooling and/or seal flushing system
----------	--

• Set of mechanical seals

2SiC	Two mechanical seals in silicon carbide (2SiC).
-------------	---

Key to product code

DRB 50/2/G50V A0BM5

① ② ③ (A) (B) (C) ④ ⑤ ⑥ ⑦ ⑧ ⑨

- | | |
|--------------------------------|----------------------------------|
| ① Family | ⑤ Hydraulic model |
| ② Series | ⑥ Version number |
| ③ Power (HPx100) / motor poles | ⑦ Motor size |
| ④ Delivery rate | ⑧ Motor phases |
| (A) TYPE (GAS thread/Flanged) | M = Single-phase |
| (B) DIAMETER (mm) | T = Three-phase |
| (C) POSITION | ⑨ Power supply voltage frequency |
| V = vertical | 5 = 50Hz |
| H = horizontal | 6 = 60Hz |

Installations

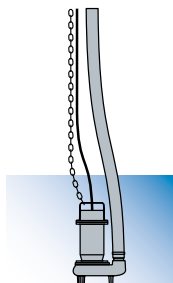

Free installation

The electric pump, standing on its feet or base, is connected to the delivery flexible pipe using a joint fixed to the discharge.

This installation allows to move easily the electrical pump

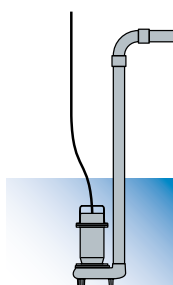

Fixed installation

The electric pump, standing on its feet or base, is connected to the delivery pipe, which is screwed to the discharge if threaded, or fixed to a bend if the port is flanged. The pump-hose connection may be threaded or flanged, depending on the pump fitting.

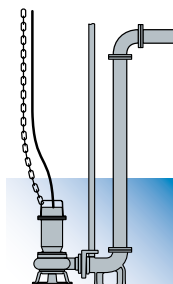

Installation with base coupling foot

For submerged installation, available for electric pumps with flanged or threaded horizontal discharge. The coupling device is fixed to the bottom of the tank and the pump is lowered in with the aid of two guide pipes fitted earlier, until the connection to the foot is completed. The delivery pipe is fixed to the coupling device discharge.

This device makes routine checks, any maintenance work or replacement of the pump extremely easy, with no need to empty the tank.

DGB

Pumps with vortex impeller

Operating ranges

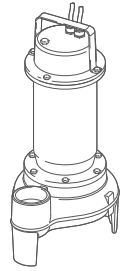
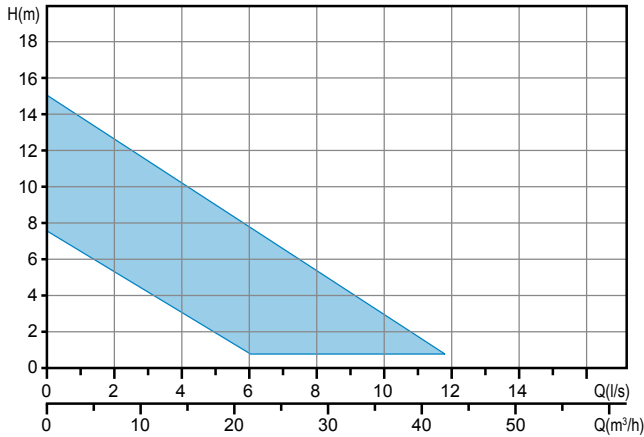

Range characteristics

Motor power	0.37 ÷ 1.5 kW
Poles	2
Insulation class	F
Degree of protection	IP68
Discharge	GAS 2" vertical
Free passage	max 38 mm
Max flow rate	10.6 l/s (636 l/min)
Max head	15 m

Motor

Oil bath motor with thermal protections.

Cable

H07RN-F 4G1 - 5 m cable length. Optional 10 m cable length.

Mechanical seals

Two silicon carbide mechanical seals (2SiC)

Applications

Suitable for lifting chemically aggressive soiled liquids, dyes and seawater. These units are therefore ideal for applications in the tanning industry, the paper industry and the shipping sector.

Installations

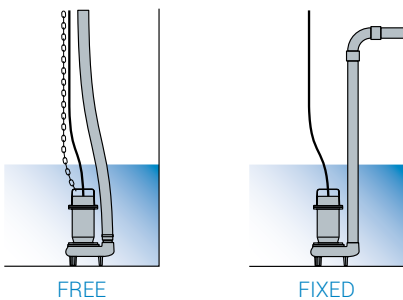

Versions

Electrical variants	T, TCST, TCSGT (single-phase models) NAE (three-phase models)
Cooling system	N
Mechanical seals	2SiC

Operating specifications

Max operating temperature	40 °C
PH of treated fluid	5 ÷ 11
Viscosity of treated fluid	1 mm²/s
Maximum immersion depth	20 m
Density of treated fluid	1 Kg/dm³
Acoustic pressure max	<70dB
Max starts per hour	30

Construction materials

Case	Bronze B10
Hydraulic parts	Bronze B10
Impeller	Bronze B10
Nuts and bolts	Stainless steel - Class A4
Standard gasket	Rubber - VITON
Shaft	Stainless steel - AISI 316
Paint type	-

DGB 2/G50V

Performances

	Flow rate											
	0	1	2	3	4	5	6	7	8	9	10	
	l/s	l/min	m ³ /h	l/s	l/min	m ³ /h	l/s	l/min	m ³ /h	l/s	l/min	m ³ /h
1 DGB 50/2/G50V A0CM(T)5	7.7	6.6	5.4	4.3	3.2	2.1						
2 DGB 75/2/G50V A0CM(T)5	8.5	7.4	6.4	5.4	4.4	3.4	2.4					
3 DGB 100/2/G50V A0CM(T)5	12.2	11.2	10.1	9.0	7.9	6.7	5.5	4.3	3.0			
4 DGB 150/2/G50V A0CM(T)5	14.0	12.9	11.8	10.7	9.5	8.3	7.1	5.9	4.6	3.3		
5 DGB 200/2/G50V A0CM(T)5	15.0	13.9	12.7	11.6	10.4	9.2	8.0	6.8	5.5	4.2	3.0	

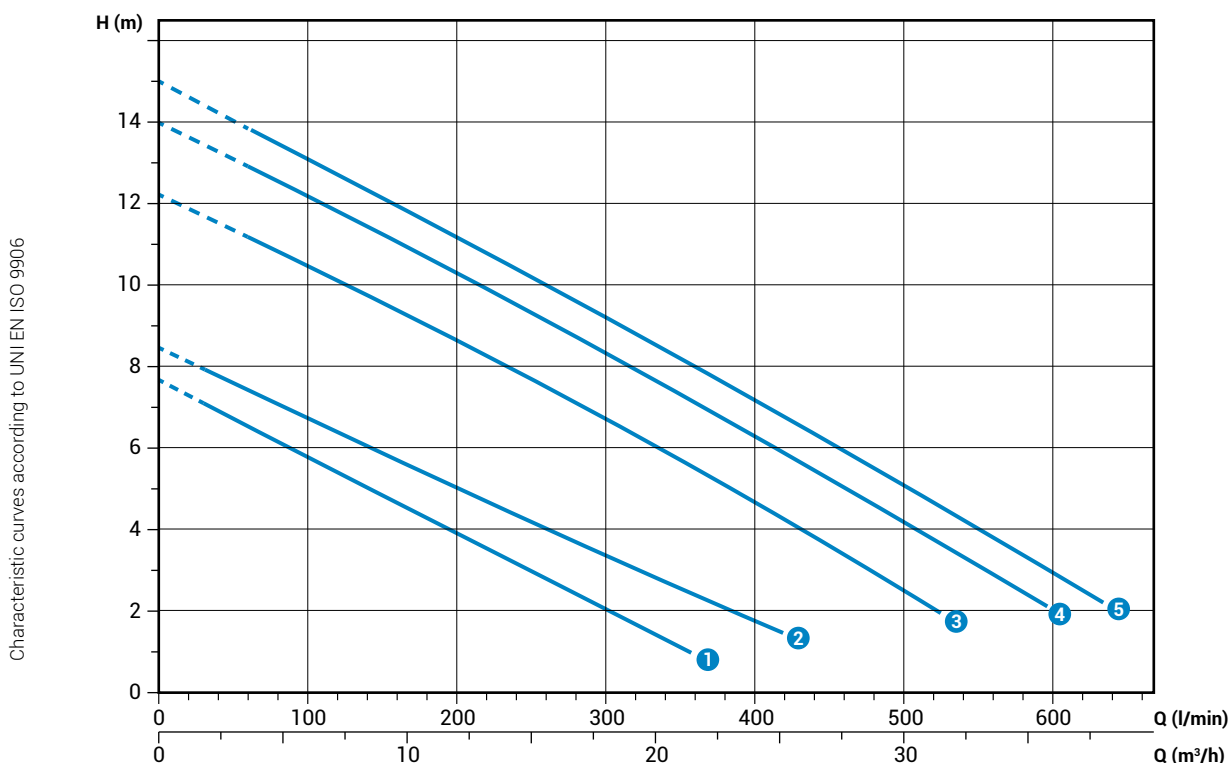

Technical data

	V	Phases	P1 (kw)	P2 (kw)	A	Rpm	Start	Cable	Ø	Free passage
1 DGB 50/2/G50V A0CM5	230	1	-	0.37	2.9	2900	Dir	4G1	G 2"	38 mm
2 DGB 75/2/G50V A0CM5	230	1	-	0.55	3.9	2900	Dir	4G1	G 2"	38 mm
3 DGB 100/2/G50V A0CM5	230	1	-	0.88	6.5	2900	Dir	4G1	G 2"	38 mm
4 DGB 150/2/G50V A0CM5	230	1	-	1.1	8.2	2900	Dir	4G1	G 2"	38 mm
5 DGB 200/2/G50V A0CM5	230	1	-	1.5	9.3	2900	Dir	4G1	G 2"	38 mm

	V	Phases	P1 (kw)	P2 (kw)	A	Rpm	Start	Cable	Ø	Free passage
1 DGB 50/2/G50V A0CT5	400	3	-	0.37	1.1	2900	Dir	4G1	G 2"	38 mm
2 DGB 75/2/G50V A0CT5	400	3	-	0.55	1.4	2900	Dir	4G1	G 2"	38 mm
3 DGB 100/2/G50V A0CT5	400	3	-	0.88	2.3	2900	Dir	4G1	G 2"	38 mm
4 DGB 150/2/G50V A0CT5	400	3	-	1.1	2.7	2900	Dir	4G1	G 2"	38 mm
5 DGB 200/2/G50V A0CT5	400	3	-	1.5	3.6	2900	Dir	4G1	G 2"	38 mm

DGB

Overall dimensions and weights

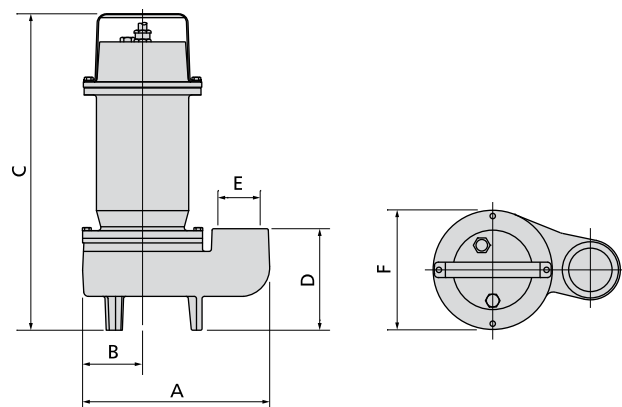

	A	B	C	D	E	F	
DGB 50/2/G50V A0CM(T)5	225	75	360	120	G 2"	155	16.5
DGB 75/2/G50V A0CM(T)5	225	75	360	120	G 2"	155	18
DGB 100/2/G50V A0CM (T)5	245	80	410	130	G 2"	155	22
DGB 150/2/G50V A0CM (T)5	245	80	410	130	G 2"	155	23
DGB 200/2/G50V A0CM (T)5	245	80	410	130	G 2"	155	26

Dimensions in mm

Packaging dimension



	X	Y	Z
DGB 50/2/G50V A0CM(T)5	225	385	245
DGB 75/2/G50V A0CM(T)5	225	385	245
DGB 100/2/G50V A0CM(T)5	285	475	235
DGB 150/2/G50V A0CM(T)5	285	475	235
DGB 200/2/G50V A0CM(T)5	285	475	235

Dimensions in mm

Pumps with multi-channel open impeller

Operating ranges

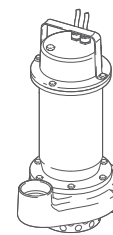
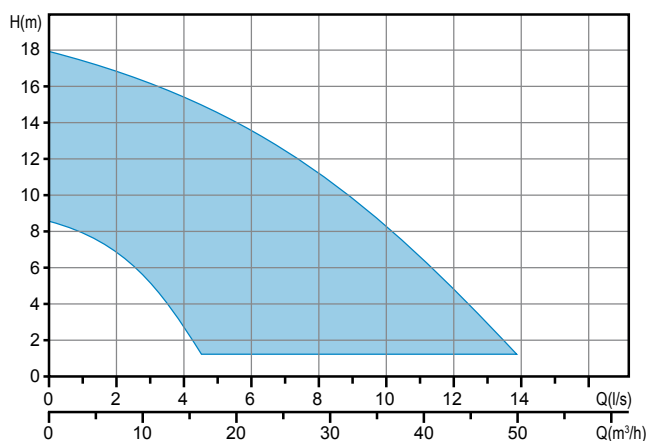

Range characteristics

Motor power	0.37 ÷ 1.5 kW
Poles	2
Insulation class	F
Degree of protection	IP68
Discharge	GAS 1 ¼ ÷ 2" vertical
Free passage	max 15 mm
Max flow rate	12.5 l/s (750 l/min)
Max head	18 m

Motor

Oil bath motor with thermal protections.

Cable

H07RN-F 4G1 - 5 m cable length. Optional 10 m cable length.

Mechanical seals

Two silicon carbide mechanical seals (2SiC)

Applications

Suitable for treating chemically aggressive strained liquids, dyes and seawater. Can be used for applications in the tanning industry and the shipping sector.

Installations

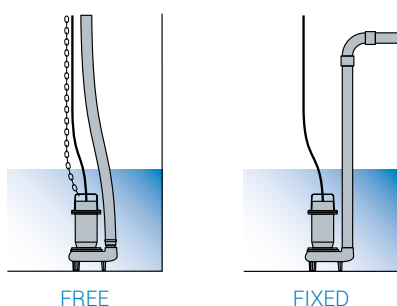

Versions

Electrical variants	T, TCST, TCSGT (single-phase models) NAE (three-phase models)
Cooling system	N
Mechanical seals	2SiC

Operating specifications

Max operating temperature	40 °C
PH of treated fluid	5 ÷ 11
Viscosity of treated fluid	1 mm ² /s
Maximum immersion depth	20 m
Density of treated fluid	1 Kg/dm ³
Acoustic pressure max	<70dB
Max starts per hour	30

Construction materials

Case	Bronze B10
Hydraulic parts	Bronze B10
Impeller	Bronze B10
Nuts and bolts	Stainless steel - Class A4
Standard gasket	Rubber - VITON
Shaft	Stainless steel - AISI 316
Paint type	-

DRB 2/G32V

Performances

	l/s	0	1	2	3	4	5	6
	l/min	0	60	120	180	240	300	360
	m ³ /h	0	3.6	7.2	10.8	14.4	18.0	21.6
① DRB 50/2/G32V A0CM(T)5		8.6	7.9	6.8	5.1	2.7		
② DRB 75/2/G32V A0CM(T)5		11.9	11.5	10.5	8.9	6.8	4.1	1.0

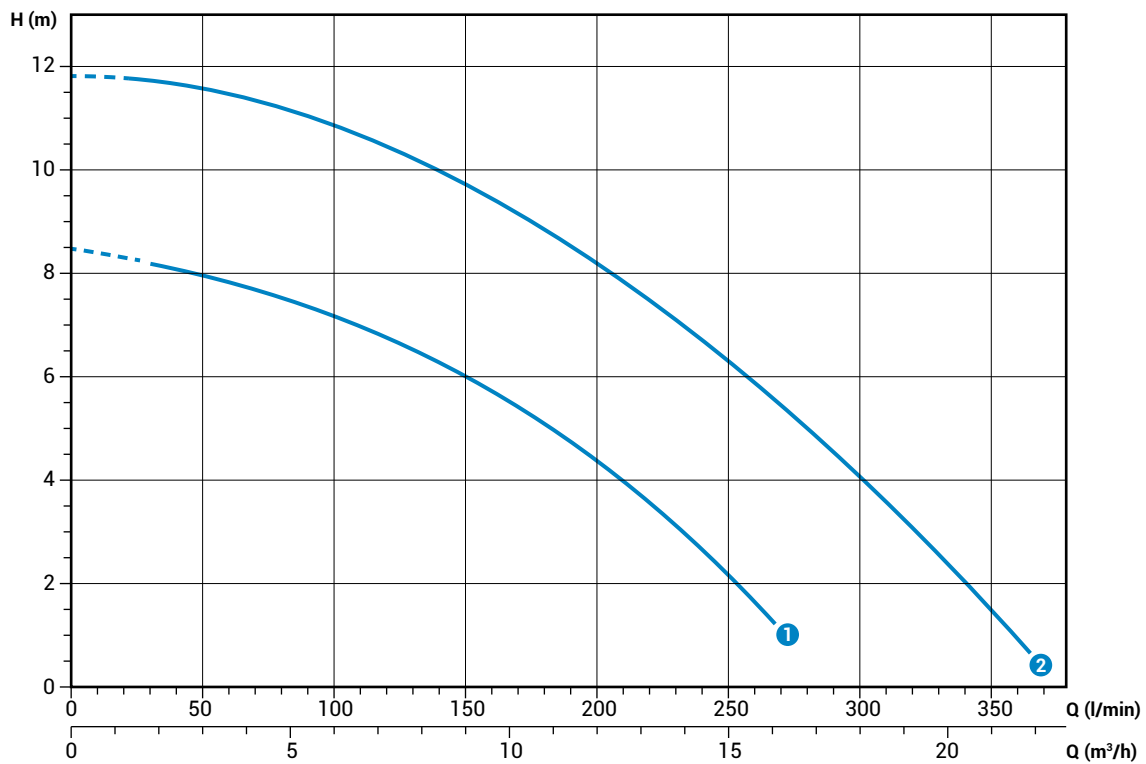

Characteristic curves according to UNI/EN ISO 9906

Technical data

	V	Phases	P1 (kW)	P2 (kW)	A	Rpm	Start	Cable	Ø	Free passage
① DRB 50/2/G32V A0CM5	230	1	-	0.37	2.9	2900	Dir	4G1	G 1 ¼"	15 mm
② DRB 75/2/G32V A0CM5	230	1	-	0.55	3.9	2900	Dir	4G1	G 1 ¼"	15 mm

	V	Phases	P1 (kW)	P2 (kW)	A	Rpm	Start	Cable	Ø	Free passage
① DRB 50/2/G32V A0CT5	400	3	-	0.37	1.1	2900	Dir	4G1	G 1 ¼"	15 mm
② DRB 75/2/G32V A0CT5	400	3	-	0.55	1.4	2900	Dir	4G1	G 1 ¼"	15 mm

DRB 2/G50V

Performances

	l/s	0	2	4	6	8	10	12
	l/min	0	120	240	360	480	600	720
	m ³ /h	0	7.2	14.4	21.6	28.8	36	43.2
① DRB 100/2/G50V A0CM(T)5		12.2	11.3	9.8	7.7	4.8		
② DRB 150/2/G50V A0CM(T)5		15.9	14.9	13.5	11.7	9.1	5.9	
③ DRB 200/2/G50V A0CM(T)5		18.0	16.8	15.4	13.5	11.2	8.4	4.9

Characteristic curves according to UNI/EN ISO 9906

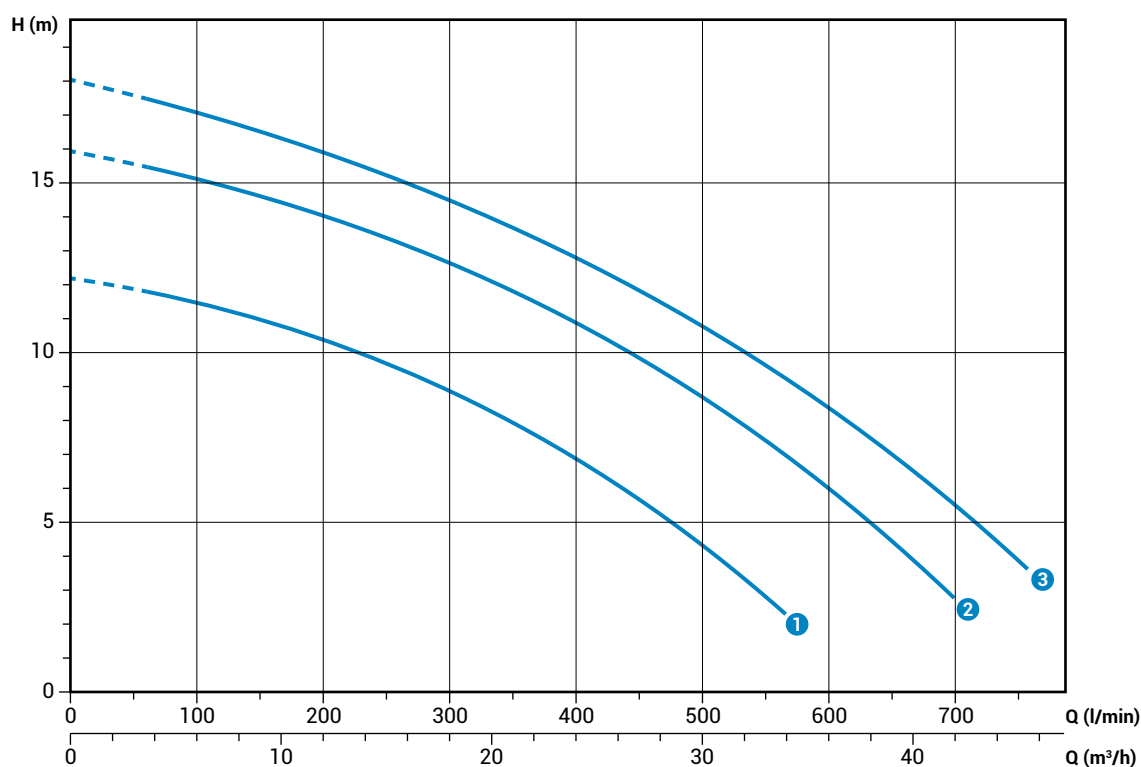

Technical data

	V	Phases	P1 (kw)	P2 (kw)	A	Rpm	Start	Cable	Ø	Free passage
① DRB 100/2/G50V A0CM5	230	1	-	0.88	6.5	2900	Dir	4G1	G 2"	15 mm
② DRB 150/2/G50V A0CM5	230	1	-	1.1	8.2	2900	Dir	4G1	G 2"	15 mm
③ DRB 200/2/G50V A0CM5	230	1	-	1.5	9.3	2900	Dir	4G1	G 2"	15 mm

	V	Phases	P1 (kw)	P2 (kw)	A	Rpm	Start	Cable	Ø	Free passage
① DRB 100/2/G50V A0CT5	400	3	-	0.88	2.3	2900	Dir	4G1	G 2"	15 mm
② DRB 150/2/G50V A0CT5	400	3	-	1.1	2.7	2900	Dir	4G1	G 2"	15 mm
③ DRB 200/2/G50V A0CT5	400	3	-	1.5	3.5	2900	Dir	4G1	G 2"	15 mm

DRB

Overall dimensions and weights

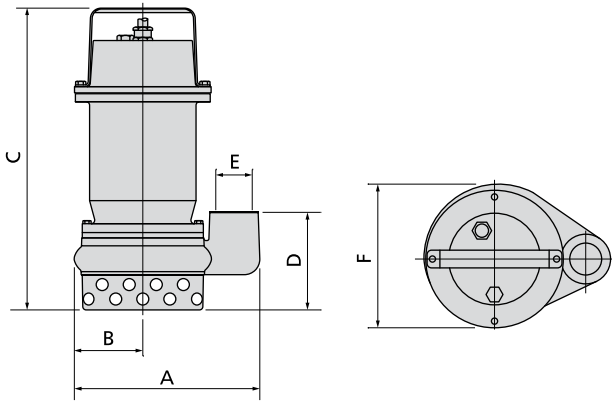

	A	B	C	D	E	F	
DRB 50/2/G32V A0CM(T)5	210	75	340	110	G 1¼"	160	17
DRB 75/2/G32V A0CM(T)5	210	75	340	110	G 1¼"	160	17
DRB 100/2/G50V A0CM(T)5	265	100	390	125	G 2"	190	21
DRB 150/2/G50V A0CM(T)5	265	100	390	125	G 2"	190	23
DRB 200/2/G50V A0CM(T)5	265	100	390	125	G 2"	190	23

Dimensions in mm

Packaging dimension



	X	Y	Z
DRB 50/2/G32V A0CM(T)5	225	385	245
DRB 75/2/G32V A0CM(T)5	225	385	245
DRB 100/2/G50V A0CM(T)5	285	475	235
DRB 150/2/G50V A0CM(T)5	285	475	235
DRB 200/2/G50V A0CM(T)5	285	475	235

Dimensions in mm

Y Series

General characteristics



- CF-8M steel construction which makes the pump suitable for use in saline environments.
- A rigid or flexible duct can be fixed to the cable gland to protect the power supply cable.
- Oil-bath motor with thermal protections.
- Shielded ball bearings with lifetime autolubrication
- Two mechanical seals in silicon carbide (2SiC) and one mechanical seal in alumina graphite (AL) for maximum reliability even in heavy-duty applications.
- Large oil sump to guarantee longer mechanical seal lifetime.
- Multichannel open impeller in CF-8M steel.
- Wide free passage allowing the expulsion of solids and preventing fouling of the impeller.

Hydraulic families



DR (Dreno)

page 32

- Multichannel open impeller in CF-8M steel.
- Designed for the treatment of strongly corrosive or chemically aggressive liquids, especially in the chemical industry, this unit is for a specific industrial application.
- Suitable for treating medium-low density fluids, containing solid and fibrous parts, sand and activated sludges.

Operating ranges

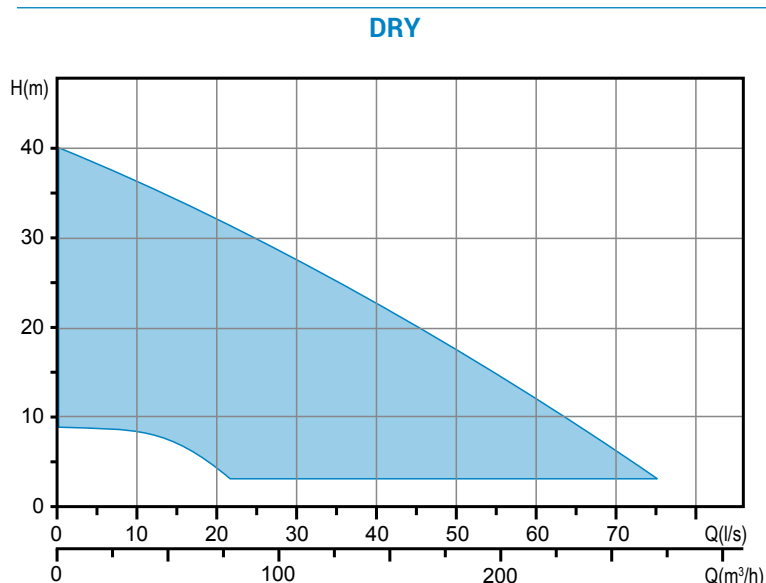

DRY

Versions available

• Electrical variants

Three-phase models

T Thermal protection

• Cooling system

N No cooling and/or seal flushing system

• Set of mechanical seals

2SICAL Two mechanical seals in silicon carbide (2SiC) and one mechanical seal in alumina graphite (AL)

Key to product code

DRY 400/2/80 A0FT5

① ② ③ ④ ⑤ ⑥ ⑦ ⑧ ⑨

- | | |
|----------------------------------|----------------------------------|
| ① Family | ⑥ Version number |
| ② Series | ⑦ Motor size |
| ③ Power (HPx100) / motor poles | ⑧ Motor phases |
| ④ Delivery rate
DIAMETER (DN) | M = Single-phase |
| ⑤ Hydraulic model | T = Three-phase |
| | ⑨ Power supply voltage frequency |
| | 5 = 50Hz |
| | 6 = 60Hz |

Installations

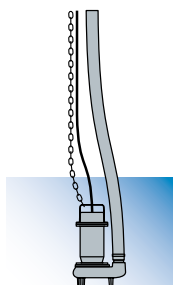

Free installation

The electric pump, standing on its feet or base, is connected to the delivery flexible pipe using a joint fixed to the discharge.

This installation allows to move easily the electrical pump

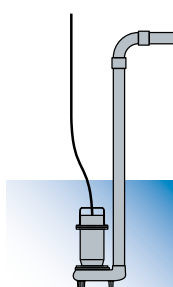

Fixed installation

The electric pump, standing on its feet or base, is connected to the delivery pipe, which is screwed to the discharge if threaded, or fixed to a bend if the port is flanged. The pump-hose connection may be threaded or flanged, depending on the pump fitting.

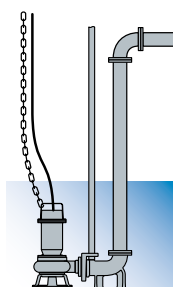

Installation with base coupling foot

For submerged installation, available for electric pumps with flanged or threaded horizontal discharge. The coupling device is fixed to the bottom of the tank and the pump is lowered in with the aid of two guide pipes fitted earlier, until the connection to the foot is completed. The delivery pipe is fixed to the coupling device discharge.

This device makes routine checks, any maintenance work or replacement of the pump extremely easy, with no need to empty the tank.

DRY

Pumps with multi-channel open impeller

Operating ranges

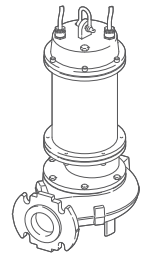
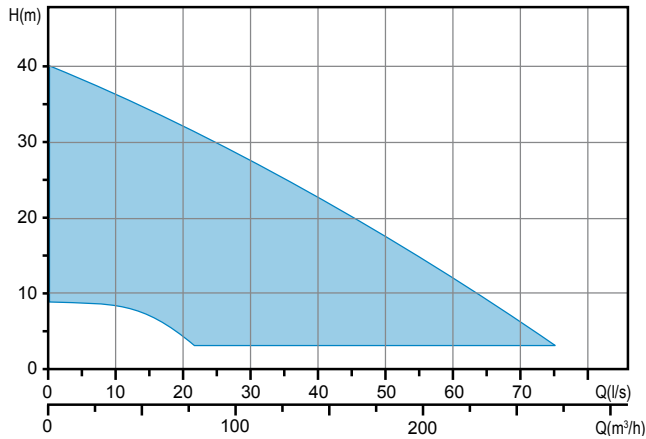

Range characteristics

Motor power	1.5 ÷ 15 kW
Poles	2/4
Insulation class	F
Degree of protection	IP68
Discharge	DN65 ÷ DN100 horizontal
Free passage	max 80 mm
Max flow rate	72.8 l/s (4368 l/min)
Max head	40.2 m

Motor

Oil bath motor with thermal protections.

Cable

H07RN-F 4G1 - 5 m cable length. Optional 10 m cable length.

Mechanical seals

Two silicon carbide mechanical seals (2SiC) and one carbon-aluminium oxide mechanical seal (AL)

Applications

Designed for the treatment of strongly corrosive or chemically aggressive liquids, especially in the chemical industry, this unit is for a specific industrial application.

Installations

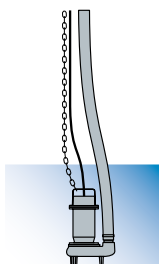

FREE

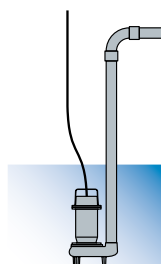

FIXED

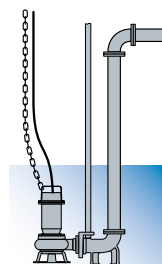

with BASE COUPLING FOOT

Versions

Electrical variants	T (three-phase models)
Cooling system	N
Mechanical seals	2SICAL

Operating specifications

Max operating temperature	40 °C
PH of treated fluid	3 ÷ 14
Viscosity of treated fluid	1 mm²/s
Maximum immersion depth	20 m
Density of treated fluid	1 Kg/dm³
Acoustic pressure max	<70dB
Max starts per hour	30

Construction materials

Case	Cast stainless steel - CF-8M (AISI 316)
Hydraulic parts	Cast stainless steel - CF-8M (AISI 316)
Impeller	Stainless steel
Nuts and bolts	Stainless steel - Class A4-70
Standard gasket	Rubber - VITON
Shaft	Stainless steel - AISI 316
Paint type	-

DRY 2/65

Performances

	l/s	0	6	12	18	24
	l/min	0	360	720	1080	1440
	m ³ /h	0	21.6	43.2	64.8	86.4
①	DRY 300/2/65 A0ET5	16.7	13.7	10.2	6.1	
②	DRY 400/2/65 A0FT5	20.5	17.4	14.2	10.7	6.7

Characteristic curves according to UNI EN ISO 9906

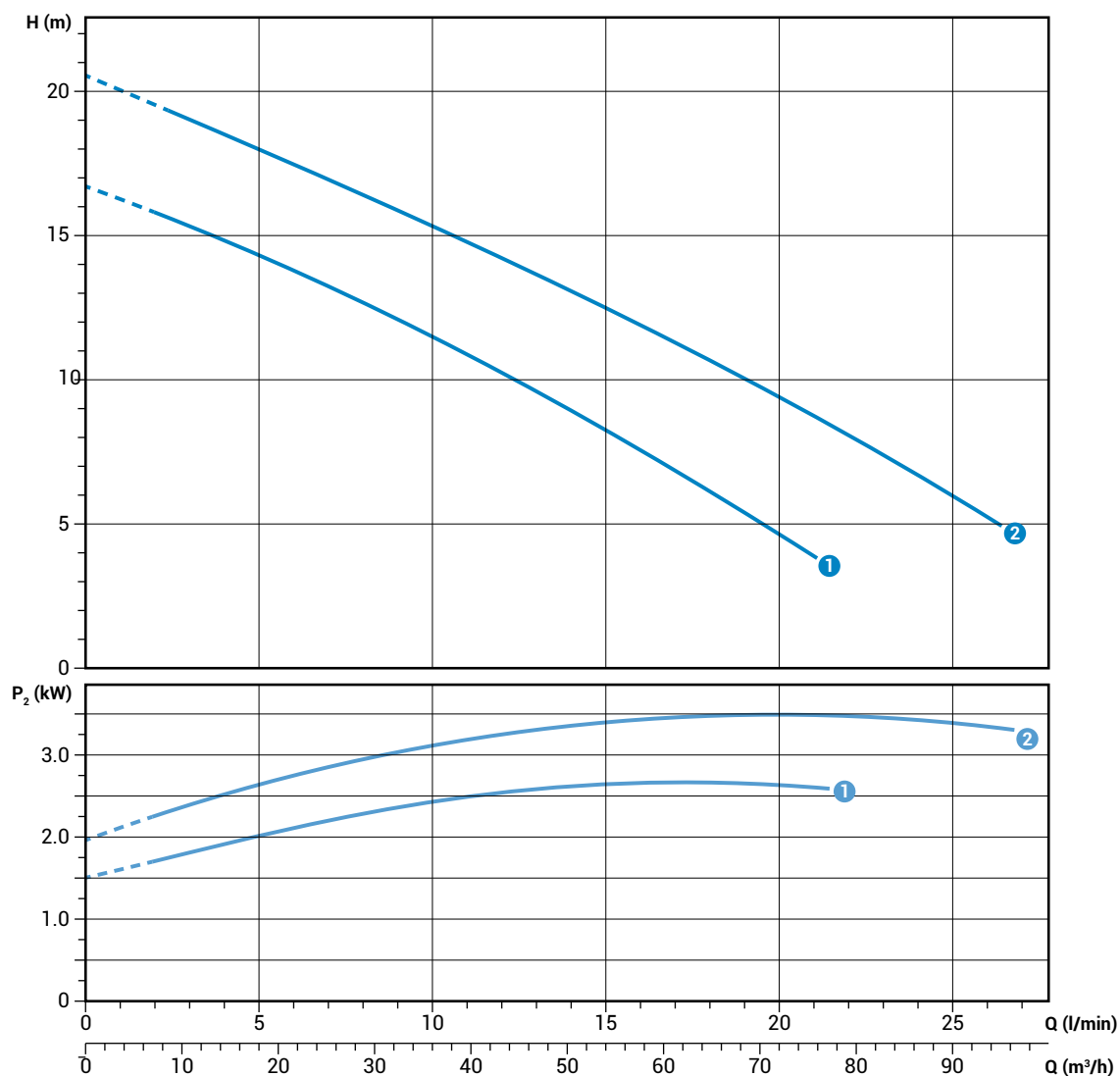

Technical data

	V	Phases	P1 (kW)	P2 (kW)	A	Rpm	Start	Cable	Ø	Free passage
①	400	3	3.7	2.7	6.0	2900	Dir	4G1.5+2G1	DN65	43 mm
②	400	3	4.7	3.6	8.0	2900	Dir	4G1.5+2G1	DN65	43 mm

DRY 2/80

Performances

	l/s	0	6	12	18	24	30	36	42	48	54
	l/min	0	360	720	1080	1440	1800	2160	2520	2880	3240
	m ³ /h	0	21.6	43.2	64.8	86.4	108	129.6	151.2	172.8	194.4
1 DRY 300/2/80 A0ET5		14.3	11.9	9.6	7.3	5.0					
2 DRY 400/2/80 A0FT5		16.6	14.4	12.1	9.6	7.1	4.4				
3 DRY 550/2/80 A0GT5		18.2	16.1	13.8	11.4	8.8	6.2	3.6			
4 DRY 750/2/80 A0HT5		22.8	20.3	17.7	15.0	12.3	9.5	6.6	3.7		
5 DRY 1000/2/80 A0HT5		29.2	26.9	24.4	21.8	19.1	16.2	13.1	9.7	6.0	
6 DRY 1500/2/80 A0HT5		40.1	38.0	35.6	33.0	30.2	27.0	23.6	19.7	15.5	10.8

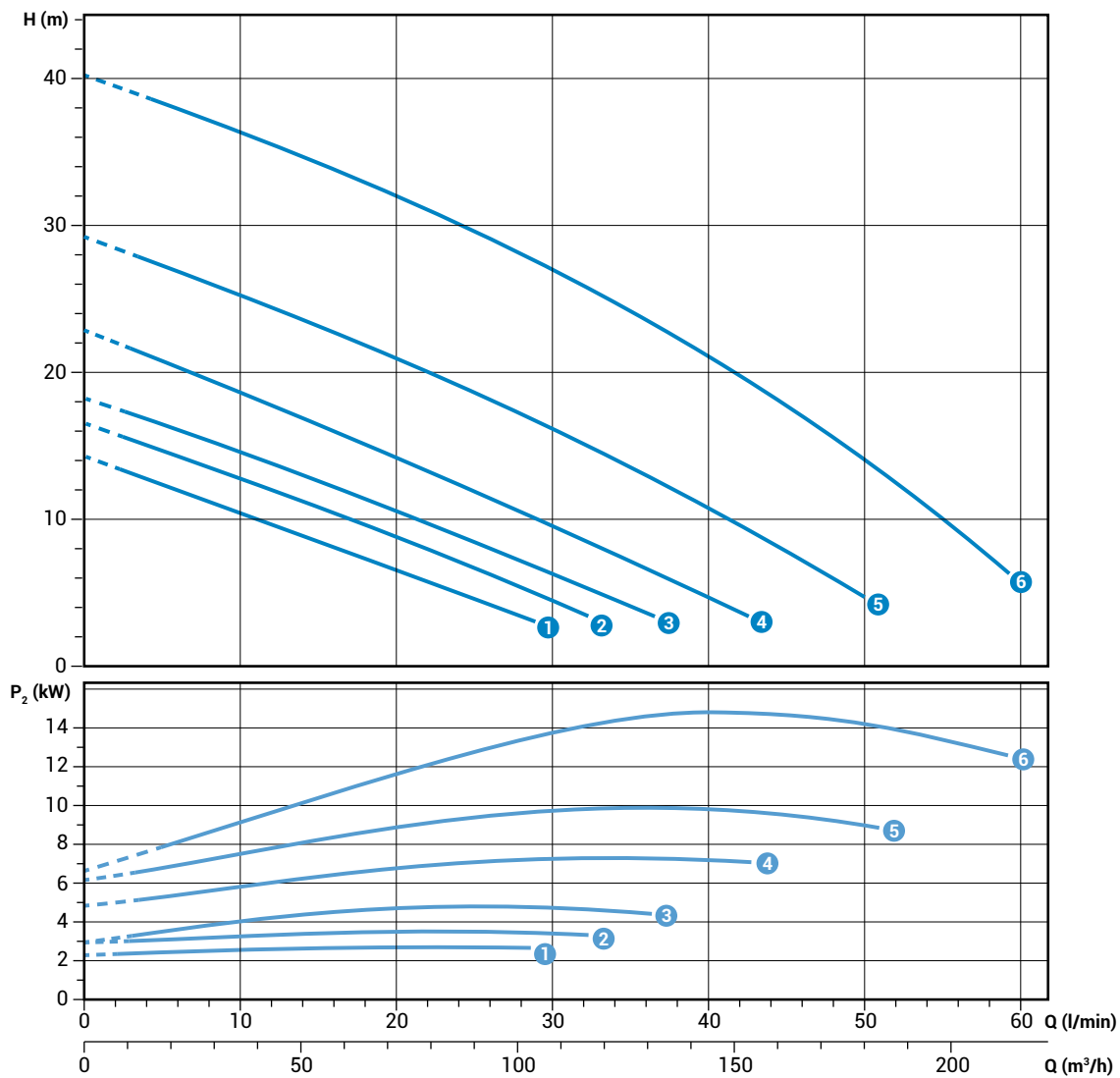

Characteristic curves according to UNI/EN ISO 9906

Technical data

	V	Phases	P1 (kW)	P2 (kW)	A	Rpm	Start	Cable	Ø	Free passage
1 DRY 300/2/80 A0ET5	400	3	3.7	2.7	6.0	2900	Dir	4G1.5+2G1	DN80	56 mm
2 DRY 400/2/80 A0FT5	400	3	4.7	3.6	8.0	2900	Dir	4G1.5+2G1	DN80	56 mm
3 DRY 550/2/80 A0GT5	400	3	5.9	4.9	10.1	2900	Dir	4G1.5+2G1	DN80	56 mm
4 DRY 750/2/80 A0HT5	400	3	8.8	7.2	14.5	2900	YΔ	2x 4G2.5+2G1	DN80	63 mm
5 DRY 1000/2/80 A0HT5	400	3	12.4	10	19.8	2900	YΔ	2x 4G2.5+2G1	DN80	65 mm
6 DRY 1500/2/80 A0HT5	400	3	17.7	15	28.2	2900	YΔ	2x 4G2.5+2G1	DN80	60 mm

DRY 2/100

Performances

	l/s	0	6	12	18	24	30	36	42	48	54	60	66	72
	l/min	0	360	720	1080	1440	1800	2160	2520	2880	3240	3600	3960	4320
	m ³ /h	0	21.6	43.2	64.8	86.4	108	129.6	151.2	172.8	194.4	216	237.6	259.2
① DRY 1000/2/100 A0HT5		23.6	22.0	20.4	18.7	17.0	15.1	13.2	11.1	8.9	6.6	4.2		
② DRY 1500/2/100 A0HT5		32.9	31.0	29.0	27.0	24.9	22.7	20.5	18.2	15.9	13.5	11.1	8.6	6.1

Characteristic curves according to UNI/EN ISO 9906

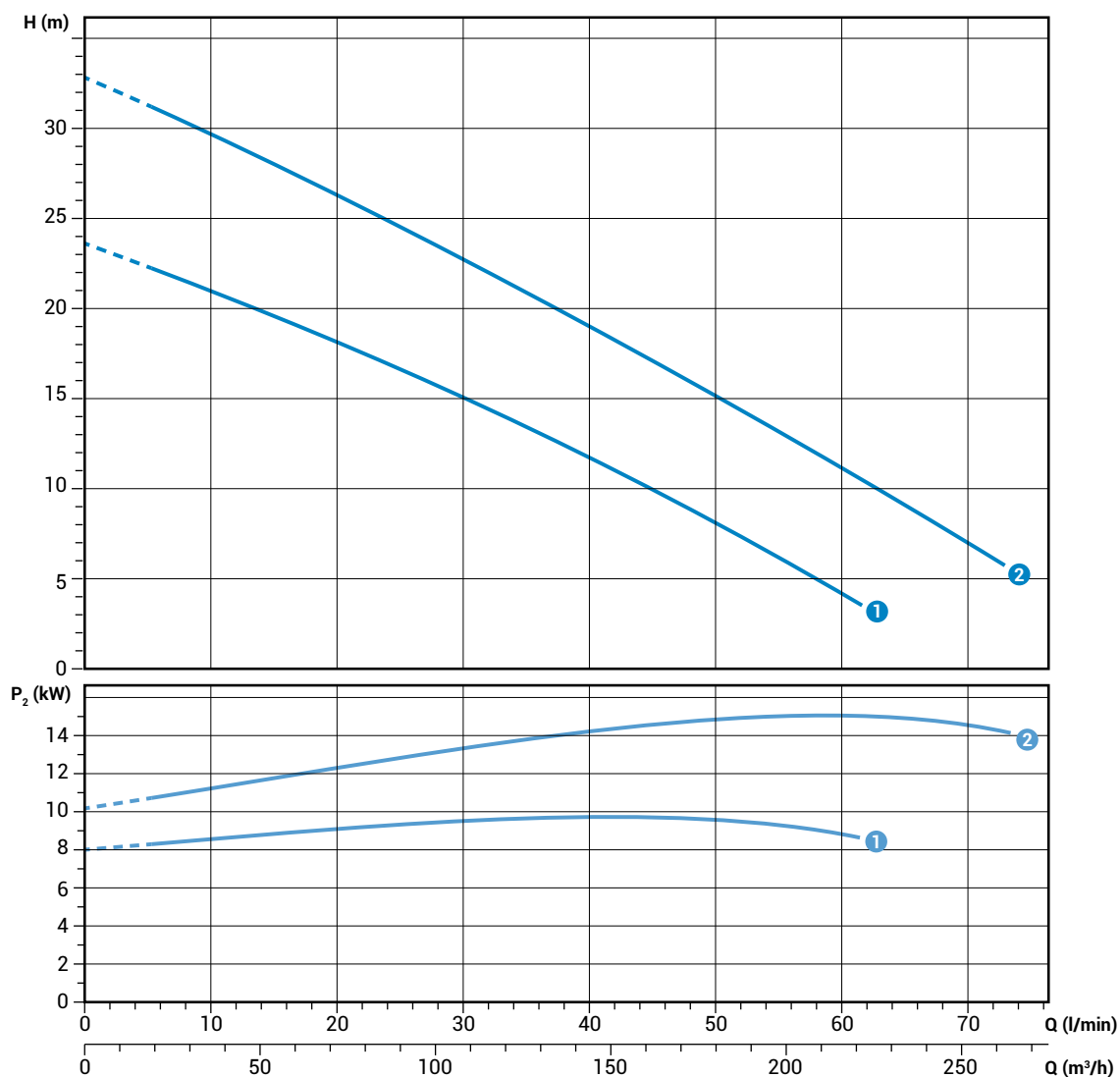

Technical data

	V	Phases	P1 (kW)	P2 (kW)	A	Rpm	Start	Cable	∅	Free passage
① DRY 1000/2/100 A0HT5	400	3	12.4	10	19.8	2900	YΔ	2x 4G2.5+2G1	DN100	80 mm
② DRY 1500/2/100 A0HT5	400	3	17.7	15	28.2	2900	YΔ	2x 4G2.5+2G1	DN100	80 mm

DRY 4/80

Performances

	l/s	0	6	12	18	24	30	36	42	48	54
	l/min	0	360	720	1080	1440	1800	2160	2520	2880	3240
	m ³ /h	0	21.6	43.2	64.8	86.4	108	129.6	151.2	172.8	194.4
① DRY 300/4/80 A0FT5		11.3	9.9	8.3	6.6	4.8					
② DRY 400/4/80 A0FT5		13.7	11.9	10.6	9.2	7.7	6.1	4.3			
③ DRY 550/4/80 A0GT5		14.6	13.2	11.8	10.4	8.8	7.2	5.5			
④ DRY 750/4/80 A0HT5		18.4	17.5	16.5	15.2	13.7	12.0	10.1	7.9	5.6	
⑤ DRY 1000/4/80 A0HT5		21.2	20.4	19.4	18.2	16.8	15.1	13.2	11.1	8.8	6.2

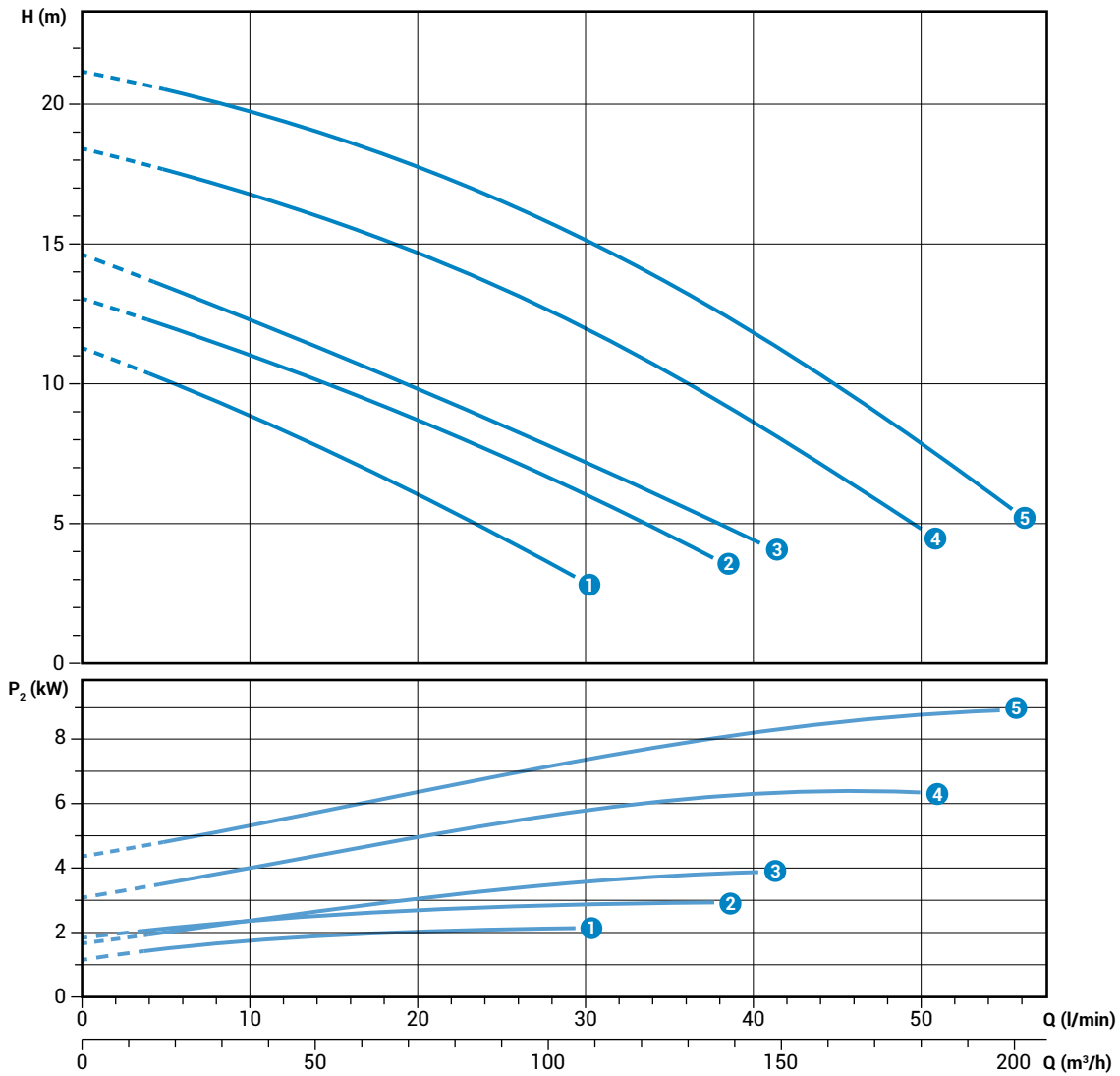

Characteristic curves according to UNI/EN ISO 9906

Technical data

	V	Phases	P1 (kW)	P2 (kW)	A	Rpm	Start	Cable	Ø	Free passage
① DRY 300/4/80 A0FT5	400	3	3.1	2.4	6.1	1450	Dir	4G1.5+2G1	DN100	67 mm
② DRY 400/4/80 A0FT5	400	3	4.1	3	7.9	1450	Dir	4G1.5+2G1	DN100	67 mm
③ DRY 550/4/80 A0GT5	400	3	5.9	4.6	10.1	1450	Dir	2x 4G2.5+2G1	DN100	67 mm
④ DRY 750/4/80 A0HT5	400	3	8.6	6.5	14.9	1450	YΔ	2x 4G2.5+2G1	DN100	70 mm
⑤ DRY 1000/4/80 A0HT5	400	3	11.5	8.9	20	1450	YΔ	2x 4G2.5+2G1	DN100	70 mm

DRY 4/100

Performances

	l/s	0	6	12	18	24	30	36	42	48	54
	l/min	0	360	720	1080	1440	1800	2160	2520	2880	3240
	m ³ /h	0	21.6	43.2	64.8	86.4	108	129.6	151.2	172.8	194.4
① DRY 300/4/100 A0FT5		8.9	8.3	7.5	6.7	5.8	4.8	3.8	2.6		
② DRY 400/4/100 A0FT5		10.8	10.1	9.4	8.6	7.7	6.7	5.6	4.5	3.3	
③ DRY 550/4/100 A0GT5		12.5	11.6	10.7	9.8	8.8	7.7	6.6	5.5	4.3	3.1

Characteristic curves according to UNI EN ISO 9906

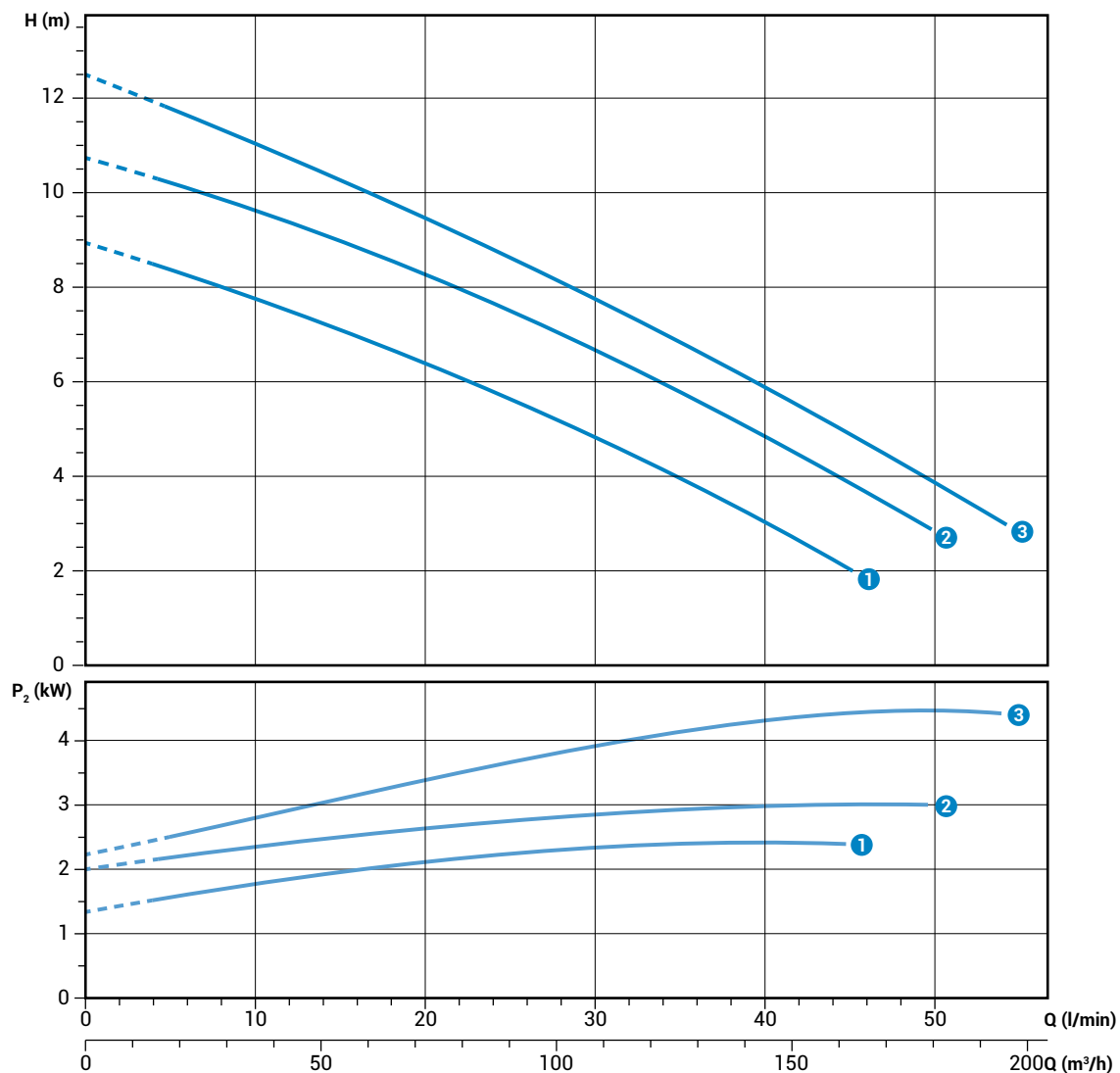

Technical data

	V	Phases	P1 (kW)	P2 (kW)	A	Rpm	Start	Cable	Ø	Free passage
① DRY 300/4/100 A0FT5	400	3	3.1	2.4	6.1	1450	Dir	4G1.5+2G1	DN100	76 mm
② DRY 400/4/100 A0FT5	400	3	4.1	3	7.9	1450	Dir	4G1.5+2G1	DN100	76 mm
③ DRY 550/4/100 A0GT5	400	3	5.9	4.6	10.1	1450	Dir	4G2.5+2G1	DN100	76 mm

DRY

Overall dimensions and weights

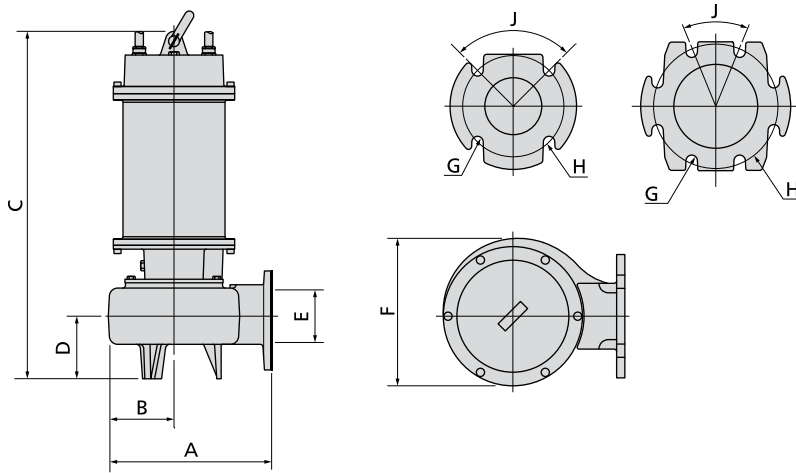

	A	B	C	D	E	F	G	H	J	kg
DRY 300/2/65 A0ET5	270	110	570	105	65	220	18	145	90°	50
DRY 400/2/65 A0FT5	270	110	645	105	65	220	18	145	90°	54
DRY 300/2/80 A0ET5	295	120	580	115	80	220	18	160	90°	51
DRY 400/2/80 A0FT5	295	120	660	115	80	235	18	160	90°	65
DRY 550/2/80 A0GT5	295	120	665	115	80	235	18	160	90°	62
DRY 750/2/80 A0HT5	390	150	755	150	80	295	18	160	90°	104
DRY 1000/2/80 A0HT5	390	150	755	150	80	295	18	160	90°	110
DRY 1500/2/80 A0HT5	390	150	755	150	80	295	18	160	90°	130
DRY 1000/2/100 A0HT5	415	160	770	155	100	310	18	180	90°	115
DRY 1500/2/100 A0HT5	415	160	770	155	100	310	18	180	90°	144
DRY 300/4/80 A0FT5	390	150	710	150	80	290	18	160	90°	73
DRY 400/4/80 A0FT5	390	150	710	150	80	290	18	160	90°	81
DRY 550/4/80 A0GT5	390	150	720	150	80	290	18	160	90°	87
DRY 750/4/80 A0HT5	440	170	775	155	80	340	18	160	90°	120
DRY 1000/4/80 A0HT5	440	170	775	155	80	340	18	160	90°	128
DRY 300/4/100 A0FT5	415	160	725	155	100	310	18	180	45°	75
DRY 400/4/100 A0FT5	415	160	720	155	100	310	18	180	45°	85
DRY 550/4/100 A0GT5	415	160	725	155	100	310	18	180	45°	91

Dimensions in mm

Packaging dimension



	X	Y	Z		X	Y	Z
DRY 300/2/65 A0ET/50	445	725	415	DRY 300/4/80 A0FT/50	445	725	415
DRY 400/2/65 A0FT/50	445	725	415	DRY 400/4/80 A0FT/50	445	725	415
DRY 300/2/80 A0ET/50	445	725	415	DRY 550/4/80 A0GT/50	445	725	415
DRY 400/2/80 A0FT/50	445	725	415	DRY 750/4/80 A0HT/50	515	915	555
DRY 550/2/80 A0GT/50	445	725	415	DRY 1000/4/80 A0HT/50	515	915	555
DRY 750/2/80 A0HT/50	515	915	555	DRY 300/4/100 A0FT/50	445	725	415
DRY 1000/2/80 A0HT/50	515	915	555	DRY 400/4/100 A0FT/50	445	725	415
DRY 1500/2/80 A0HT/50	515	915	555	DRY 550/4/100 A0GT/50	445	725	415
DRY 1000/2/100 A0HT/50	515	915	555				
DRY 1500/2/100 A0HT/50	515	915	555				

Dimensions in mm

Hydraulic performance data

DGX	l/s	0	2	4	6	8	10	12	14	16	18
	l/min	0	120	240	360	480	600	720	840	960	1080
	m ³ /h	0	7.2	14.4	21.6	28.8	36.0	43.2	50.4	57.6	64.8
DGX 50/2/G50V A0CM(T)5		7.6	5.4	3.2							
DGX 75/2/G50V A0CM(T)5		8.4	6.3	4.3	2.4						
DGX 100/2/G50V A0CM(T)5		12.1	10.0	7.8	5.4	2.9					
DGX 150/2/G50V A0CM(T)5		13.9	11.7	9.4	7.0	4.6					
DGX 200/2/G50V A0CM(T)5		14.9	12.6	10.3	7.9	5.5	2.9				
DGX 150/2/65 A0CM(T)5		9.1	8.5	7.7	6.7	5.5	4.1	2.5			
DGX 200/2/65 A0CM(T)5		9.6	9.1	8.4	7.5	6.4	5.1	3.7	2.0		
DGX 200/2/80A A0CM(T)5		8.1	7.5	6.8	5.9	5.1	4.3	3.5	2.7	1.9	
DGX 100/4/G50V A0CM(T)5		5.0	4.4	3.8	3.1	1.6					
DGX 150/4/65 A0CM(T)5		5.6	5.3	4.8	4.3	3.6	2.8	1.8			
DGX 150/4/80 A0CM(T)5		5.1	4.8	4.5	4.0	3.5	3.1	2.6	2.1	1.6	1.1

DRX	l/s	0	2	4	6	8	10	12
	l/min	0	120	240	360	480	600	720
	m ³ /h	0	7.2	14.4	21.6	28.8	36	43.2
DRX 50/2/G32V A0CM(T)5		8.5	6.7	2.6				
DRX 75/2/G32V A0CM(T)5		11.8	10.5	6.7	1.0			
DRX 100/2/G50V A0CM(T)5		12.0	11.1	9.7	7.6	4.8		
DRX 150/2/G50V A0CM(T)5		15.8	14.8	13.4	11.5	9.0	5.9	
DRX 200/2/G50V A0CM(T)5		17.8	16.7	15.2	13.4	11.1	8.3	4.8

DGB	l/s	0	1	2	3	4	5	6	7	8	9	10
	l/min	0	60	120	180	240	300	360	420	480	540	600
	m ³ /h	0	3.6	7.2	10.8	14.4	18.0	21.6	25.2	28.8	32.4	36.0
DGB 50/2/G50V A0CM(T)5		7.7	6.6	5.4	4.3	3.2	2.1					
DGB 75/2/G50V A0CM(T)5		8.5	7.4	6.4	5.4	4.4	3.4	2.4				
DGB 100/2/G50V A0CM(T)5		12.2	11.2	10.1	9.0	7.9	6.7	5.5	4.3	3.0		
DGB 150/2/G50V A0CM(T)5		14.0	12.9	11.8	10.7	9.5	8.3	7.1	5.9	4.6	3.3	
DGB 200/2/G50V A0CM(T)5		15.0	13.9	12.7	11.6	10.4	9.2	8.0	6.8	5.5	4.2	3.0

DRB	l/s	0	2	4	6	8	10	12
	l/min	0	120	240	360	480	600	720
	m ³ /h	0	7.2	14.4	21.6	28.8	36	43.2
DRB 50/2/G32V A0CM(T)5		8.6	6.8	2.7				
DRB 75/2/G32V A0CM(T)5		11.9	10.5	6.8	1.0			
DRB 100/2/G50V A0CM(T)5		12.2	11.3	9.8	7.7	4.8		
DRB 150/2/G50V A0CM(T)5		15.9	14.9	13.5	11.7	9.1	5.9	
DRB 200/2/G50V A0CM(T)5		18.0	16.8	15.4	13.5	11.2	8.4	4.9

Hydraulic performance data

DRY

	l/s	0	6	12	18	24	30	36	42	48	54	60	66	72
	l/min	0	360	720	1080	1440	1800	2160	2520	2880	3240	3600	3960	4320
	m ³ /h	0	21.6	43.2	64.8	86.4	108	129.6	151.2	172.8	194.4	216	237.6	259.2
DRY 300/2/65 A0ET5		16.7	13.7	10.2	6.1									
DRY 400/2/65 A0FT5		20.5	17.4	14.2	10.7	6.7								
DRY 300/2/80 A0ET5		14.3	11.9	9.6	7.3	5.0								
DRY 400/2/80 A0FT5		16.6	14.4	12.1	9.6	7.1	4.4							
DRY 550/2/80 A0GT5		18.2	16.1	13.8	11.4	8.8	6.2	3.6						
DRY 750/2/80 A0HT5		22.8	20.3	17.7	15.0	12.3	9.5	6.6	3.7					
DRY 1000/2/80 A0HT5		29.2	26.9	24.4	21.8	19.1	16.2	13.1	9.7	6.0				
DRY 1500/2/80 A0HT5		40.1	38.0	35.6	33.0	30.2	27.0	23.6	19.7	15.5	10.8			
DRY 1000/2/100 A0HT5		23.6	22.0	20.4	18.7	17.0	15.1	13.2	11.1	8.9	6.6	4.2		
DRY 1500/2/100 A0HT5		32.9	31.0	29.0	27.0	24.9	22.7	20.5	18.2	15.9	13.5	11.1	8.6	6.1
DRY 300/4/80 A0FT5		11.3	9.9	8.3	6.6	4.8								
DRY 400/4/80 A0FT5		13.1	11.9	10.6	9.2	7.7	6.1	4.3						
DRY 550/4/80 A0GT5		14.6	13.2	11.8	10.4	8.8	7.2	5.5						
DRY 750/4/80 A0HT5		18.4	17.5	16.5	15.2	13.7	12.0	10.1	7.9	5.6				
DRY 1000/4/80 A0HT5		21.2	20.4	19.4	18.2	16.8	15.1	13.2	11.1	8.8	6.2			
DRY 300/4/100 A0FT5		8.9	8.3	7.5	6.7	5.8	4.8	3.8	2.6					
DRY 400/4/100 A0FT5		10.8	10.1	9.4	8.6	7.7	6.7	5.6	4.5	3.3				
DRY 550/4/100 A0GT5		12.5	11.6	10.7	9.8	8.8	7.7	6.6	5.5	4.3	3.1			



better together